

AUTO ROLL 1.55 m / 1.2 T

réf . 063839

GYS

MADE IN FRANCE

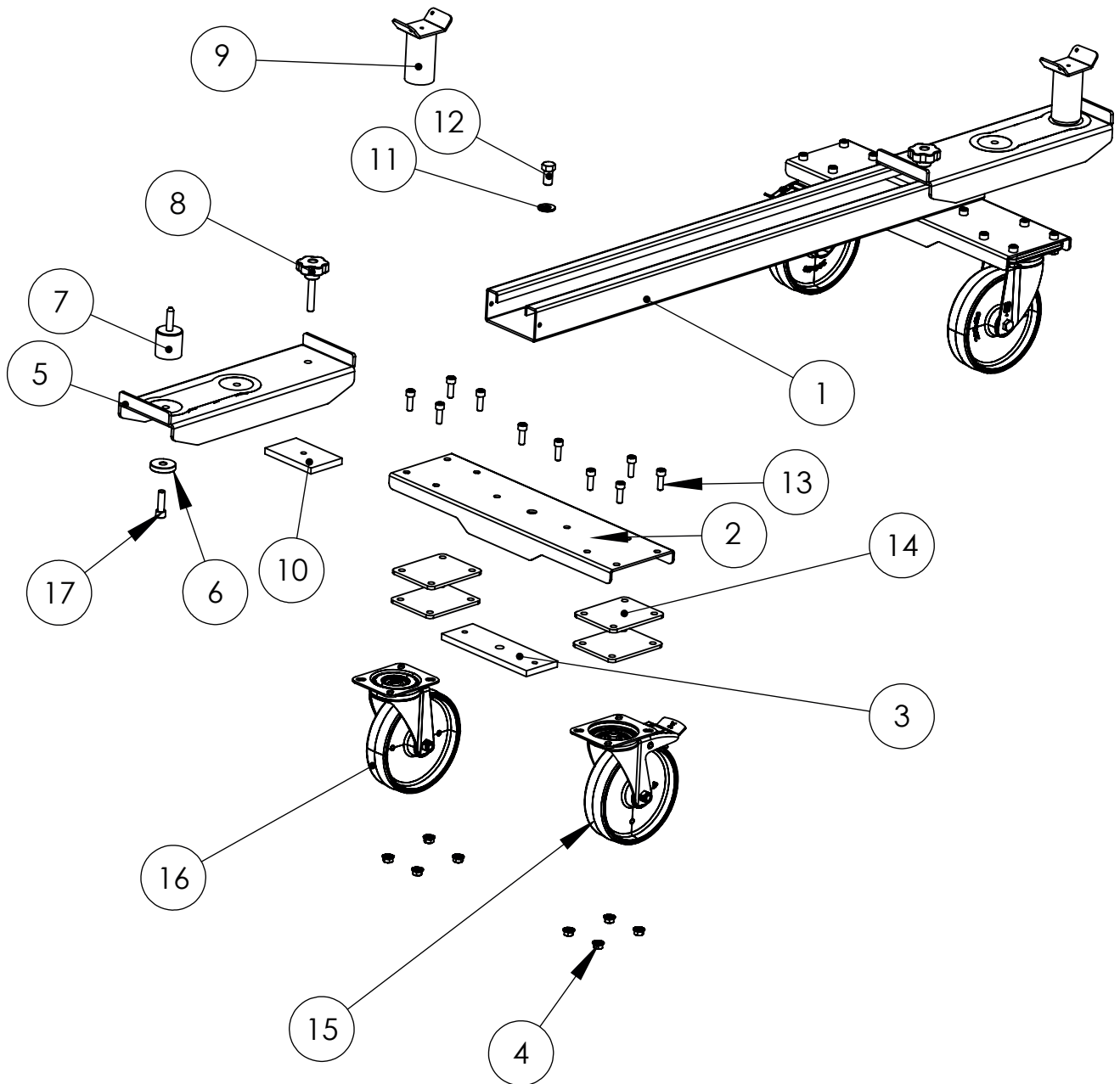

1	Poutre	10	Plat de serrage
2	Support roues	11	Rondelle M 16
3	Plat renfort bas	12	Vis M 16x30
4	Ecrou M10 cranté zn blanc din 6923 cl 8	13	Vis mx M10x30 CHC acier brut din 912 cl 12.9
5	Glissière de levage	14	Plaque de réhausse roue épaisseur 6mm acier
6	Rondelle renfort basse	15	Roue pivotante à frein polyamide
7	Pied acier	16	Roue pivotante polyamide
8	Vis de serrage glissière	17	Vis mx M12x40 CHC zn blanc din 912 cl 12.9
9	Patin d'appui		

AUTO ROLL 1.55 m / 1.2 T

réf . 063839

GYS

MADE IN FRANCE

1

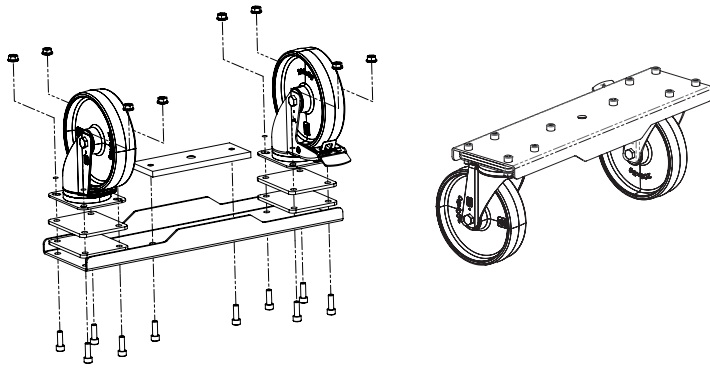

2

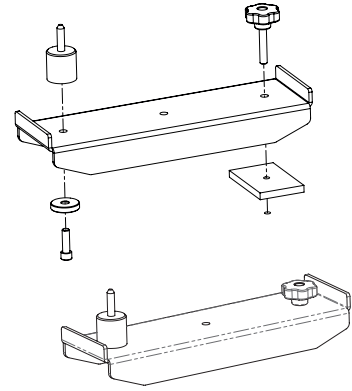

3

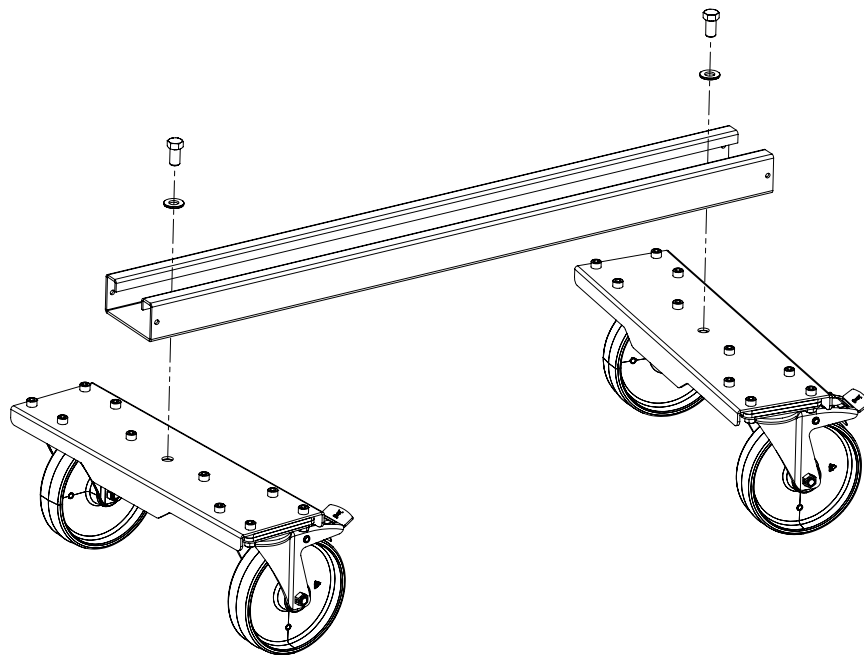

4

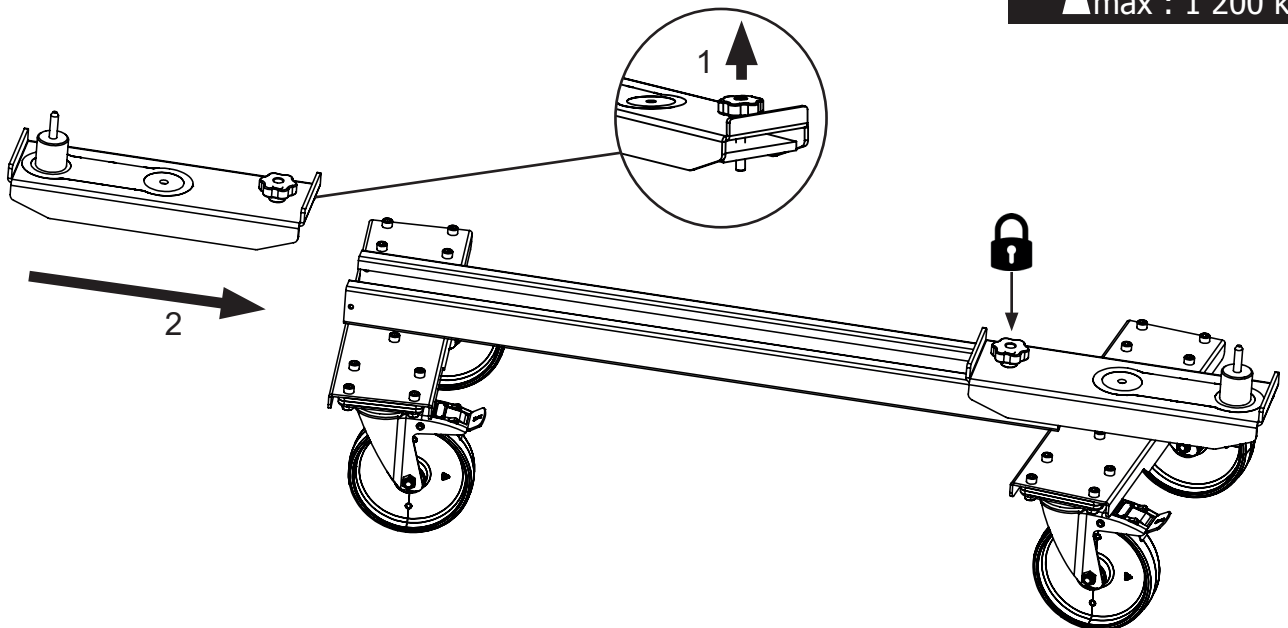

 max : 1 200 kg