

- SPOTTER
- DENT PULLER
- MIG
- PLASMA
- INDUCTION
- LIFT
- RIVETING
- ACCESSORIES



INVEST IN THE FUTURE



French manufacturer
since 1964

Car Body Welding Systems

Catalogue Carrosserie

Catalogo Carrozzeria

Karosserie-Schweißtechnik Katalog

Catálogo de Soldadura para Carrocería

2
0
2
2





GYS FRANCE
Laval

🕒 1964
👥 × 600

Created in 1964, GYS is a French industrial group with 850 employees around the world. Built around continuous investment in Research & Development and in the acquisition of knowledge, the company is now a major player in the design and manufacture of welding machines, battery chargers and car body repair equipment.

“ The market realities are constantly changing and the size of our family business requires us to quickly adapt to new contexts and new challenges.

We are convinced that our future is closely linked to the future of our partners. This is why we do everything in our power to understand what distributors and users expect from us and what challenges they face every day. To support them in facing these challenges, we wish to become and remain their privileged partner on the path we will travel together. ”

Bruno Bouygues,
C.E.O.



Nicolas & Bruno Bouygues

A worldwide coverage

125 countries



visit with
📺 Youtube

INVEST IN THE FUTURE

FR

Créé en 1964, GYS est un groupe industriel français regroupant plus de 850 collaborateurs dans le monde. Fort d'un centre de recherche de premier plan, GYS est un acteur majeur dans la conception et la fabrication d'équipements de soudage, de chargeurs de batteries et de systèmes de réparation carrosserie.

Les nouvelles réalités du marché sont en perpétuel changement et la taille de notre entreprise familiale nous impose une adaptation rapide aux nouveaux contextes et à leurs enjeux.

Nous sommes convaincus que notre avenir est étroitement lié à celui de nos clients. Pour cela, nous mettons tout en oeuvre pour comprendre ce que les distributeurs et les utilisateurs attendent de nous, savoir à quels défis ils font face et voir dans quelle mesure nous pouvons leur permettre de les relever afin de devenir et rester leur partenaire privilégié pour le chemin que nous avons à parcourir ensemble.

DE

GYS wurde 1964 gegründet und ist ein französisches Familienunternehmen mit mehr als 850 Mitarbeitern auf der ganzen Welt. Dank einem erstklassigen Forschungszentrum ist GYS ein wichtiger Akteur in der Entwicklung und Herstellung von Schweißgeräten, Batterieladegeräten und Karosseriereparatursystemen.

Neue Marktbedingungen sind in fortwährender Veränderung und die Größe unseres Familienunternehmens veranlasst eine rasche Anpassung an neue Umstände und an ihre Herausforderungen.

Wir sind überzeugt, dass unsere Zukunft eng mit der unserer Kunden verbunden ist. Dafür setzen wir all unser Können ein, um zu verstehen, was die Händler und Anwender von uns erwarten, welchen Herausforderungen sie gegenüberstehen und um zu schauen, in welchem Maße wir sie unterstützen können, damit wir ihr bevorzugter Partner werden und bleiben auf dem Weg, den wir gemeinsam beschreiten.

IT

Nato nel 1964, GYS è un gruppo industriale francese che raggruppa oltre 850 collaboratori nel mondo. Forte di un centro di ricerca di grande importanza, GYS è uno dei maggiori protagonisti nella progettazione e fabbricazione di apparecchiature per la saldatura e il taglio, di cariche batterie booster e avviatori e sistemi di riparazione delle carrozzerie.

Le realtà del mercato sono in continuo cambiamento e richiedono risposte immediate. Le dimensioni della nostra impresa familiare consentono un adattamento rapido ai nuovi contesti e alle loro problematiche.

Siamo convinti che il nostro futuro sia strettamente legato a quello dei nostri clienti. Per questo noi mettiamo il massimo impegno per capire quello che i distributori e i loro clienti/utilizzatori si aspettano da noi, quali sfide devono affrontare e come possiamo aiutarli per farli crescere, per diventare e restare loro partner di riferimento per proseguire insieme sul cammino del successo.

👥
850 people

🏠
55 000 m²
590 000 sqf
2 factories

🇩🇪 GYS GERMANY
Aachen

🕒 2006
👥 × 70

🇬🇧 GYS U.K.
Rugby

🕒 2008
👥 × 35

🇨🇳 GYS CHINA
Shanghai

🕒 2004
👥 × 130

🇮🇹 GYS ITALIA
Venezia

🕒 2015
👥 × 15

Partners





GYS ACADEMY

Training centre dedicated to professionals
 Centre de formation agréé
 Trainingcenter für Profis
 Centro di formazione dedicato ai professionisti
 Ref. 52 53 0068153

3 catalogues

2700+ references



DENT PULLING

NEW
 GYSPOT
 p.6

Accessories, levelling bars
 p.16

Workstations
 p.20

NEW
 Pulling systems
 p.26

Paintless repair
 p.32

MOBILE PNEUMATIC LIFT

NEW
 SPOT LIFT
 p.34

AUTO ROLL & accessories
 p.34

ERGO LIFT & accessories
 p.36

TROLLEY IW1
 p.37

SPOT WELDING

Overview
 p.38

Traditional
 PORTASPOT
 p.40

GYSPOT 32D
 p.40

Inverter
 GYSPOT 100R
 p.41

GYSPOT BP & PTI
 p.42

X & C Arms
 p.44

Genius
NEW
 GYSPOT G
 p.46

G Arms
 p.50
 Consumables & accessories
 p.51

RIVETING

NEW
 GYSPRESS
 p.52

Accessories & consumables
 p.56

MIG WELDING

GYS AUTO
 p.62

MULTIPEARL
 p.64

NEW
 AUTOPULSE
 p.66

Helmets, accessories & consumables
 p.70

INDUCTION

NEW
 GYSDUCTION COMBIDUCTION
 p.78

NEW
 POWERDUCTION
 p.80

PLASMA

NEW
 CUTTER & EASYCUT
 p.84

+ MORE

- Windscreen repair p.86
- Bumper repair p.88
- Tools p.90
- Dust vacuum p.95 **NEW**
- Working lights p.96
- Working supports p.98
- Safety protections p.100

CHARGERS & BSU

NEW
 GYSFLASH & MORE
 p.102

Advanced R&D

85

Metal work
 Tôlerie
 Blechbearbeitung

Painting & marking
 Peinture & marquage
 Lackierstraße

Assembly
 Montage/tests
 Montage

Electronics
 Électronique
 Elektronik

Mechanical
 Mécanique
 CNC-Bearbeitung

Transformers
 Transformateurs
 Transformatoren

Cable work
 Filerie
 Kabelkonfektionierung

100%

in house production



GYSPOT

DENT PULLING

ACIER / STEEL / STAHL

- Étoiles - Stars - Ausbeulstern
- Anneaux - Rings - Zugösen
- Fils ondulés - Wavy wires - Wellendraht
- Rabattage d'impact - Impact shrinking - Glätten

OPTIONS

Consommables - Consumables p.10

Chariots - Trolleys p.20

- Étoiles - Stars - Ausbeulstern
- Anneaux - Rings - Zugösen
- Fils ondulés - Wavy wires - Wellendraht
- Rabattage d'impact - Impact shrinking - Glätten
- Rétreinte - Tempering - Temperieren

NEW



FIXED GUN

FIXED GUN

GYSPOT 2600

2600 A **1x1 AUTOMATIC**

230V • 1~

052208

included

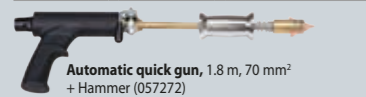

Automatic quick gun, 1.8 m, 70 mm²
+ Hammer (057272)

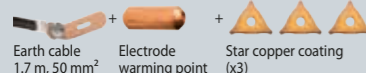

Earth cable 1.7 m, 50 mm² | Electrode warming point | Star copper coating (x3)

GYSPOT 2700

2600 A **1x1 MANUAL**

230V • 1~

055353

included

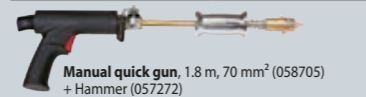

Manual quick gun, 1.8 m, 70 mm² (058705)
+ Hammer (057272)

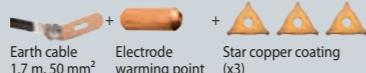

Earth cable 1.7 m, 50 mm² | Electrode warming point | Star copper coating (x3)

GYSPOT 34.02 & 34.04

3500 A **1x1 MANUAL**

230V • 1~

GYSPOT 34.02
065741

NEW

400V • 2~

GYSPOT 34.04
067943

NEW

included

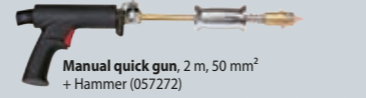

Manual quick gun, 2 m, 50 mm²
+ Hammer (057272)

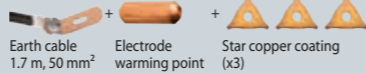

Earth cable 1.7 m, 50 mm² | Electrode warming point | Star copper coating (x3)

QUICK GUNS

Quick & Easy

AUTOMATIC



WITH CONNECTOR
2 m, Ø 70 mm²
included 39.02/04
057517



WITH CONNECTOR
3 m, Ø 50 mm²
included PRO 230/400
057500

WITH CONNECTOR
3 m, Ø 70 mm²
included EXPERT 200/230/400
059207

MANUAL



WITH CONNECTOR
cable 2 m, Ø 70 mm²
included PRO 230/400,
EXPERT 200/230/400,
COMBI 230EPRO
057524

included electrode warming point:



No connector
cable 1.8 m, Ø 70 mm²
for 2700
058705

PATENTS REGISTERED NUMBERS
001830845-0001
EUROPEAN TRADEMARK & DESIGN

- Étoiles - Stars - Ausbeulstern
- Anneaux - Rings - Zugösen
- Fils ondulés - Wavy wires - Wellendraht
- Rabattage d'impact - Impact shrinking - Glätten
- Rétreinte - Tempering - Temperieren
- Rivets - Rivets - Nieten
- Rondelles - Rings - Unterlegscheiben
- Goujons - Studs - Gewindebolzen

SYNERGIC CONTROL

PATENTS REGISTERED NUMBERS
EUROPEAN TRADEMARK & DESIGN



EXPERT SYNERGIC
& MANUAL CONTROL

Welding current adjustment | Welding time adjustment



GUN WITH CONNECTOR

GYSPOT 39.02 & 39.04

3800 A **1x1 AUTOMATIC**

230V • 1~

GYSPOT 39.02
052215

400V • 2~

GYSPOT 39.04
052222

included

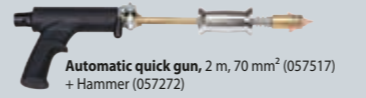

Automatic quick gun, 2 m, 70 mm² (057517)
+ Hammer (057272)



Earth cable 2 m, 70 mm² | SPOTTER BOX STANDARD (053915)
(Details p.10)

GYSPOT PRO 230 & PRO 400

3800 A **2x2 AUTOMATIC**

230V • 1~

GYSPOT PRO 230
052178

400V • 2~

GYSPOT PRO 400
052185

included

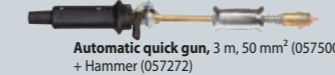

Automatic quick gun, 3 m, 50 mm² (057500)
+ Hammer (057272)

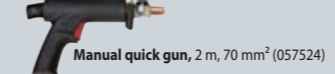

Manual quick gun, 2 m, 70 mm² (057524)



Earth cable 2 m, 70 mm² | SPOTTER BOX PRO (050075)
(Details p.10)

GYSPOT EXPERT 200, 230 & 400

3800-4500 A **2x2 AUTOMATIC**

230V • 1~

GYSPOT EXPERT 230
066885

NEW

200-240V • 1~

GYSPOT EXPERT 200
058842

ideal

400V • 2~

GYSPOT EXPERT 400
058859

4500 A

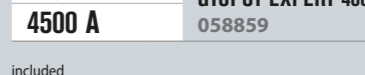

Automatic quick gun, 3 m, 70 mm² (059207)
+ Hammer (057272)

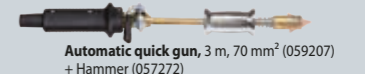

Manual quick gun, 2 m, 70 mm² (057524)

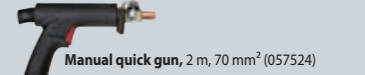

Earth cable Thick 3 mm
2 m, 70 mm² | SPOTTER BOX PRO (050075)
(Details p.10)

MADE IN GYS CHINA	G NORM 62135	50/60 Hz	I ₂ max A	U ₂ V	I _{AM} A	I _{RMS} A	kW	OK	OK	MANUAL	SYNERGIC	AUTOMATIC	MANUAL	SEPARATE CABLE GUN	cm	kg
MADE IN GYS CHINA	GYSPOT 2600	230V	2 m	2600	5,4	16	1800	10	OK	—	—	—	—	—	20 x 32 x 18	15
	GYSPOT 2700	230V	2 m	2600	5,4	16	1800	10	OK	—	—	—	—	—	20 x 32 x 18	14,5
	GYSPOT 34.02	230V	2 m	3500	7,4	16	2500	20	OK	OK	—	—	—	—	22,5 x 36 x 23,5	21
	GYSPOT 34.04	400V, 2ph	4 m	3500	7,4	16	2500	20	OK	OK	—	—	—	—	22,5 x 36 x 23,5	21
MADE IN FRANCE	GYSPOT 39.02	230V	4 m	3800	7,4	16	2800	20	OK	OK	—	—	—	—	22,5 x 36 x 23,5	22
	GYSPOT 39.04	400V, 2ph	4 m	3800	7,4	16	2800	20	OK	OK	—	—	—	—	22,5 x 36 x 23,5	22
	GYSPOT PRO 230	230V	8 m	3800	7,4	16	2800	20	OK	OK	—	—	—	—	22,5 x 36 x 23,5	20,5
	GYSPOT PRO 400	400V, 2ph	8 m	3800	7,4	16	2800	20	OK	OK	—	—	—	—	22,5 x 36 x 23,5	20,5
	GYSPOT EXPERT 200	200-240V	8 m	4350-5100	7,2-8,7	30(D)	3100-3600	25-36	OK	OK	—	—	—	—	22,5 x 36 x 23,5	24,5
	GYSPOT EXPERT 230	230V	8 m	3800	7,4	16	2800	20	OK	OK	—	—	—	—	22,5 x 36 x 23,5	20,5
	GYSPOT EXPERT 400	400V, 2ph	8 m	4500	7,4	16(D)	3200	25	OK	OK	—	—	—	—	22,5 x 36 x 23,5	22,5

GYSPOT

STEEL DENT PULLING



GYSPOT ALU

DENT PULLING ALU



FV FLEXIBLE VOLTAGE

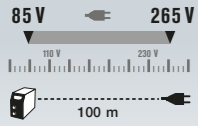

FIXED GUN

GYSPOT ALU PRO FV

100 · 230V · 1~
7500 A x1 AUTOMATIC

FV

021990

included



Automatic alu gun
3 m, 25 mm²



ALU BOX STANDARD (050020)
(Details p.11)

ALU GUN

AUTOMATIC

3 m, Ø 25 mm²

included ALU PRO FV
& COMBI 230
E.PRO



(x 3)
065635

66 mF CAPACITOR
DISCHARGE
WELDING

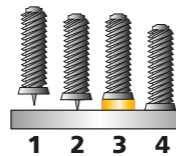

Joint rings for
mandrel Ø 4/5/6
x 2
060814

PATENTS REGISTERED NUMBERS
002446450-0001
EUROPEAN TRADEMARK & DESIGN

SYNERGIC CONTROL

PATENTS REGISTERED NUMBERS
EUROPEAN TRADEMARK & DESIGN

Alu



Goujons - Studs

Acier / Steel / Stahl



- ▼ Étoiles - Stars
- ⌋ Anneaux - Rings
- 〰 Filis ondulés - Wavy wires
- ⌋ Rabattage d'Impact - Impact shrinking
- ⌋ Rétreinte - Tempering
- T Rivets - Rivets
- Rondelles - Rings
- ⌋ Goujons - Studs



GYSPOT COMBI



DENT PULLING ALU + ACIER / STEEL / STAHL

3 GUNS INCLUDED



GUN WITH CONNECTOR

GYSPOT COMBI 230 E.PRO

230V · 1~
3800 A Acier / Steel / Stahl
7500 A Alu

x3
AUTOMATIC
MANUAL
AUTOMATIC

021266

included



Manual quick gun, 2 m, 70 mm² (057524)



Automatic alu gun, 3 m, 25 mm²

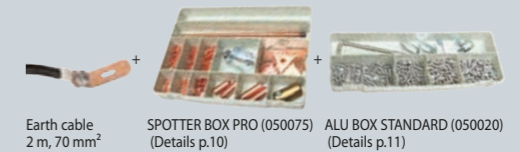

Earth cable
2 m, 70 mm²

SPOTTER BOX PRO (050075)
(Details p.10)

ALU BOX STANDARD (050020)
(Details p.11)

OPTIONS

Consommables - Consumables
p.10



Accessoires ALU - ALU accessories
p.17



Chariots - Trolleys
p.20



MADE IN FRANCE 62135	50/60 Hz	I ₂ max A	U ₂ V	I _{AM} A	I _{RMS} A	kW	MANUAL	SYNERGIC	AUTOMATIC	MANUAL	SEPARATE CABLE GUN	3 m	Included Alu box	21 x 24 x 36	12.5
GYSPOT ALU PRO FV	110 > 230V	2 m	7500	50 > 200	5	0.65	OK	OK	■	■	—	3 m	Included Alu box	21 x 24 x 36	12.5
GYSPOT COMBI 230 E.PRO	230V	8 m	3800 (steel) 7500 (alu)	7,4 (steel) 50 > 200 (alu)	16	2800 (steel)	OK	OK	—	■	■	2/3 m	Included Spotter box + Alu box	45 x 43 x 29	42.5

GYSPOT

ALU + STEEL DENT PULLING



GYSPOT ACCESSORIES & CONSUMABLES



ACIER / STEEL / STAHL



DENT BOX CONSUMABLES / BAR / EASY
SPOTTER BOX STANDARD / 2600 / 2700



SPOTTER BOX PRO

Étoile - Star - Ausbeulstern	Rondelle - Ring - Unterlegscheiben	Rétreinte - Tempering - Temperieren	Rabattage d'impact & Écrou - Impact shrinking & Lock nut - Glätten	Fil ondulé - Wavy wire - Wellendraht
 chuck for inertia hammer copper coating star electrode ø 16 for 8 x 16 ø 8 x 16 earth hook carbon heating electrode	 electrode ø 16 for 8 x 16 ø 8 x 16 earth hook	 carbon heating electrode	 electrode warming point ø 16 Ball electrode warming point ø 16 M8 for spot welding machine only	 electrode wavy wire magnetic positioner
x1 x20	x1 x100 x1	x5	x1 x1 x100	x1 x50 x1
049482 052239	049574 049444 056718	049468	049567 059726 050303	049789 049727 049772

Anneaux - Rings - Zugösen	Goujons - Studs - Gewindebolzen	Rivets - Rivets - Nieten	Clous - Nails	Molette - Stitch welding
 electrode straight rings twisted rings lifting rod	 electrode for threaded studs rivets ø 5 - M5, M6 threaded M5 x 18 x 0.8 self-threading ø 5 x 18 ø 5 x 12	 electrode ø 16, 3 x 4,50 ø 3 x 3,25 ø 3 x 4,50	 electrode ø 2 - M4 ø 2	 electrode wheel ø 16 flat n°27 Earth plate large magnetic
x1 x100 x50 x3 180, 300, 500 mm 050792	x1 x100 x100 x100	x1 x100 x100	x1 x100	x1
050655 050648 050631 050792	049598 049383 049420 049413	049604 049345 049352	049277 041561	050310

Rubber pad 062399

DENT BOX

BEST SELLER

CONSUMABLES 051515	x20
BAR 050037	x1 x25
EASY 053632	x1 x1 x1 x10 x1 x50 x1 x1 x1 x1 x25 x1 x50 x1 x180mm x1 180mm

SPOTTER BOX

PRO 050075	x1 x1 x1 x20 x1 x50 x1 x1 x1
STANDARD 053915	x1 x1 x1 x20 x1 x50 x1 x1 x1
2600 052277	x20 x1 x50 x1
2700 053922	x20 x1 x50 x1 x1

x1 x50 x50 x50 x1 x100 x100

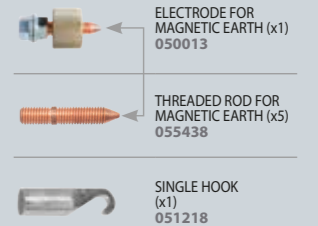

Mandrins pour pistolets - Mandrels for gun - Pistole & Anschlußstücke, Zubehör

Pour débousseurs - for dent pullers - Anschlußstück für Ausbeulspotter-Pistole

Pour soudeuses par point - for spot welding machines - Anschlußstück für Monopunktpistole

QUICK GUN 057531



D1 048959



S1 < nov 2010 048171



S2 - NEW > nov 2010 048188



Écrou - Nut 053199

Microswitch 053267

Masse pistolet acier - Steel gun earth adapter - Masse für Stahl Pistole



ALU



ALU BOX LIGHT Ø4 / STANDARD Ø4 / Ø5 & 6

ALU BOX

LIGHT Ø 4 051522	ø 4 x200
STANDARD Ø 4 050020	ø 4 x200
Ø 5 & 6 048195	x1 x1 ø 5 x100 + ø 6 x100

Joint rings for mandrel Ø 4/5/6 x2 060814

mandrel for ALU GUN	alu magnesium screws 12 mm	alu silicium screws 12 mm	screwable rings	fast pulling rings	lifting rod
ø 4 x2 049000 ø 5 x1 048157 ø 6 x1 048164	ø 4 - M4 x200 050273 ø 4 - M4 x1000 050129 ø 5 x100 048140 ø 6 x100 048133	ø 4 - M4 x200 050280 ø 4 - M4 x1000 050136 ø 5 x100 048126 ø 6 x100 048003	ø 4 x5 050297	x5 058712	x3 : 180, 300, 500 mm 050792



GYSPOT ARC PULL

DRAWN ARC DENT PULLING



ALU + ACIER / STEEL / STAHL

SYNERGIC

EXPERT Control

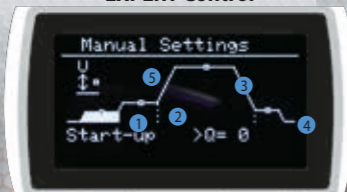

- Anneaux - Rings - Zugösen
- Goujons - Studs - Gewindebolzen
- Tiges inox - Stainless steel nails - Edelstahlnägel
- 1 Amorce - Start-up - Zündung
- 2 Décapage - Scouring (I & t) - Abbeizen
- 3 Arc (I & t) - Arc - Lichtbogen
- 4 Accroche - Hitching (I & t) - Verklebung
- 5 Hauteur - Height - Höhe

MANUAL



7 languages
FR, EN, DE, SP, IT, NL & RU

PFC POWER FACTOR CORRECTION

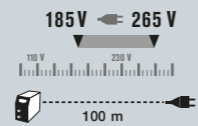

FV FLEXIBLE VOLTAGE

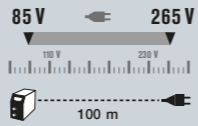

SR SECONDARY REGULATION

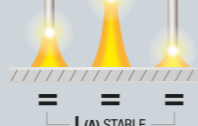

AD ANTI-DUST

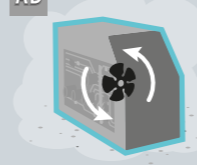

SPECIAL TEARING RIVETS

Spécial arrachage de rivets - Spezial-Zugnieten

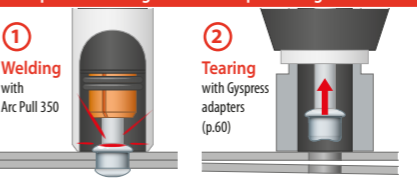

NEW



Ø max
Alu: 6 mm
Fe: 5 mm



Ø max
Alu/Fe: 8 mm



Ø max
Alu: 8 mm
Fe: 12 mm

SYNERGIC DIGITAL GUNS

UNIQUE
Linear Motor

DRAWN ARC PROCESS
Gas protection

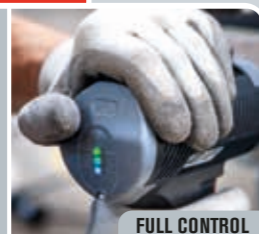

Consumables for Gun
x2 059627
x1 059610

GYSPOT ARC PULL 200

100 · 230V · 1~

200 A x1 MANUAL

FV SR AD

057470

included



Manual synergic gun
3 m, 25 mm²

ALU RING BOX 1.5 mm
(AlSpec + AlMg3 + AlMgSi)
059429

x1

Lifting rod 180 mm
(x3)

OPTIONS

details p.20



Weld 810
for ARC PULL 200 & 350
037489

Weld 810 XL
for ARC PULL 700
070967

GYSPOT ARC PULL 350

208 · 240V · 1~

350 A x1 MANUAL

PFC SR AD

062191

included



Manual synergic gun
3 m, 25 mm²

PACKS
ARC PULL 350

	Arc Pull 350	Croco T400.70 043787	Rivet box 064584	Alu ring box 1.5 mm 059429	Lifting rods 059610	Lifting rods 050792
350 RIVET 064645	■	■	■	—	—	—
350 PULLER 064652	■	—	—	■	x1	180, 300, 500 mm
350 PULLER + RIVET 064669	■	■	■	■	x1	180, 300, 500 mm

GYSPOT ARC PULL 700

380 · 480V · 3~

680 A x1 MANUAL

SR IP 23

068315

included

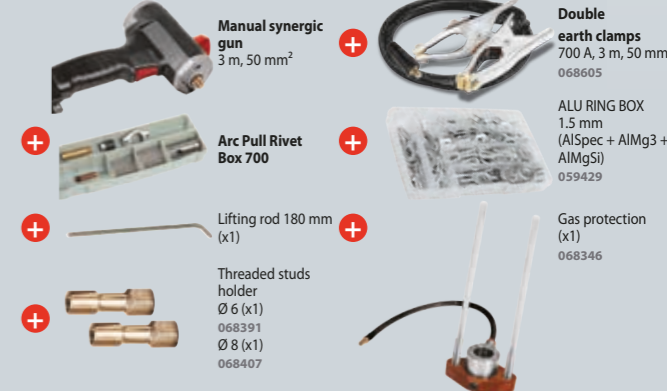

Manual synergic gun
3 m, 50 mm²

Double earth clamps
700 A, 3 m, 50 mm²
068605

Arc Pull Rivet Box 700

ALU RING BOX
1.5 mm
(AlSpec + AlMg3 + AlMgSi)
059429

Lifting rod 180 mm
(x1)

Gas protection
(x1)
068346

Threaded studs holder
Ø 6 (x1)
068391
Ø 8 (x1)
068407

MADE IN FRANCE 60974-1	50/60 Hz	I ₂ A	SYNERGIC	TECHNOLOGY		U ₂		kW	cm	ArcPull	ArcPull + gun				
				Acier/Steel	Alu	Power Factor Correction	Flexible Voltage					V	A		
GYSPOT ARC PULL 200	110 · 230V	6 m	10 · 100 (110V) 10 · 200 (230V)	■	Manual + Digital Gun Motion Control	—	■	2.4 (110V) 5.6 (230V)	16	2.4 (110V) 5.6 (230V)	OK	OK	20.5 x 25 x 33	8.6 kg	11.9 kg
GYSPOT ARC PULL 350	208 · 240V	6 m	10 · 350	■	Manual + Digital Gun Motion Control	—	—	20.4 · 34V	16	11.9	OK	OK	30 x 24.5 x 22	11 kg	14.3 kg
GYSPOT ARC PULL 700	3x 400V 3x 480V	6 m	10 · 680	■	Manual + Digital Gun Motion Control	—	—	20.4 · 44V	20 A (D) 16 A (D)	35 kW	OK	OK	32 x 32.4 x 41	16 kg	19.3 kg



GYSPOT ARC PULL 200 & 350 ACCESSORIES & CONSUMABLES



ACIER / STEEL / STAHL

	x1	x1	x1	x100	x100	x2	x100	x100	x1	x100	x100	x100	x1	x100	x200	x1	x200	x1	x100
STEEL STUDS BOX 350 059443	x1	x1				x1	x100		x1	x100	x100	x100							

ALU

	x1	x1	x2	x100	x1	x100	x1	x100	x200	x1	x200	x1	x100
ALU STUDS BOX 350 059436	x1	x1	x1	x100	x1	x100	x1	x100					

	straight rings						twisted rings						
	Al-Special		AlMg3		AlMgSi		Al-Special		AlMg3 - x 50		AlMgSi - x 50		
box	n°1 1mm	n°4 1.5mm	n°8 2mm	n°2 1mm	n°5 1.5mm	n°3 1mm	n°6 1.5mm	n°1 1mm	n°4 1.5mm	n°2 1mm	n°5 1.5mm	n°3 1mm	n°6 1.5mm
	x100	x100	x100	x100	x100	x100	x100	x50	x50	x50	x50	x50	x50
	059535	059559	065703	059498	059511	059450	059474	059542	059566	059504	059528	059467	059481
box	ALU RING BOX 1 mm 059412												
	1mm x50		1mm x50		1mm x50		1mm x20		1mm x20		1mm x20		
box	ALU RING BOX 1.5 mm 059429												
	1.5mm x50		1.5mm x50		1.5mm x50		1.5mm x20		1.5mm x20		1.5mm x20		
sachet - bag	ALU RING BOX 2 mm 065703												
	2mm x100												

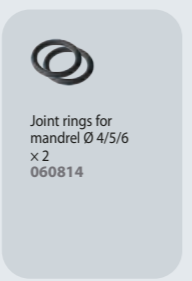

STUDS HOLDER BOX 350 064591	x1	x1	x1	x1	x1	x1	x1	x1							
ARC PULL DIFFICULT ACCESS BOX 350 070813	x1	x1									x1	x1	x1	x1	x1

ARC PULL RIVET BOX 350 064584	x100	x1	x1	x1	x1				

GYSPOT ARC PULL 700 - ACCESSORIES & CONSUMABLES

ARC PULL RIVET BOX 700 068452	x100	x1	x1	x1	x2	x1	x1		



FAST DENT PULLING



ACIER / STEEL / STAHL

EASY TOOL CONNECTION

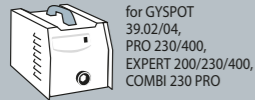

for GYSPT
39.02/04,
PRO 230/400,
EXPERT 200/230/400,
COMBI 230 PRO

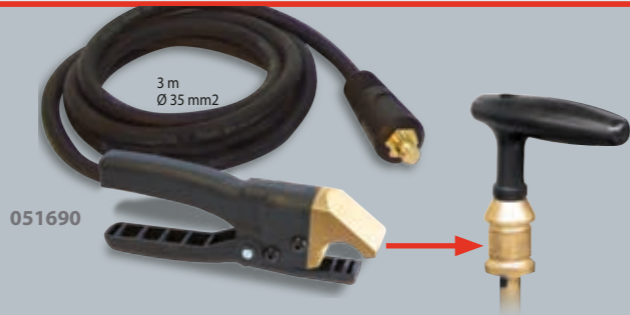

051690

3 m
Ø 35 mm²

 051584 380 g	 Anneaux - Rings - Anschweißösen 051652	 Fils ondulés - Wavy wires - Wellendraht 051669	 Rétreinte - Tempering - Glättwerkzeug 051676	 EASYGUN 051317	 Box of 3 electrodes for accessories 050822	 Poignée de tirage manuel 057289
---------------------	---	---	---	-----------------------	---	--

MANUSPOT =



Tools set & support
for SPOT 600, 800, 1000, 1600,
Workstation & Dentstation



MANULINER
050471

3 m
Ø 35 mm²

MANULINER/GUN =

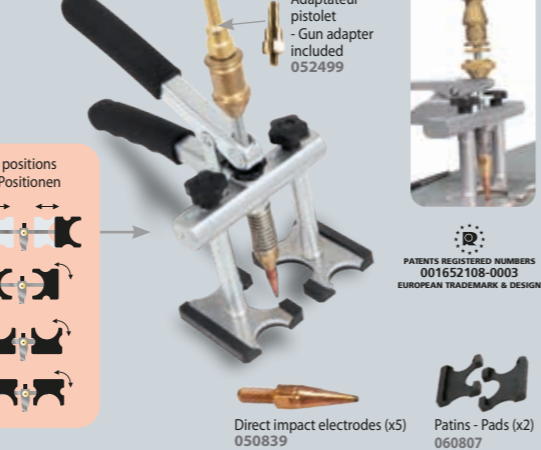

4 positions
4 Positionen

Direct impact electrodes (x5)
050839 Patins - Pads (x2)
060807

PATENTS REGISTERED NUMBERS
001652108-0003
EUROPEAN TRADEMARK & DESIGN

FAST & EASY



RINGMATIC

052154

included
(x 50)



Option
Adaptateur
pistolet - Gun
adapter
052499

LAMPE LIGNE DROITE

- Straight line lamp
- Dentline-laser



056770

QUICK SPOT AIR GUN V2

057340
LIGHT
920 g



2,5 m

AIR

QUICK SPOT AIR GUN V2 + Mini-fraiseuse - Mini-Druckluftfräser



057340 + 063228

Included
Tungsten drill Ø 6 mm
054172

Adaptateur pistolet - Gun adapter
052826

ALU

ARC PULLER PREMIUM

ULTRA RESISTANT
No deformation

Full rotation
GRIP

Multi positions

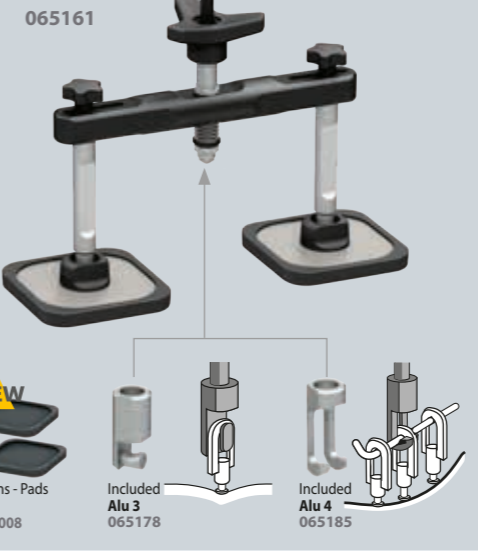

065161

NEW
Patins - Pads
(x2)
069008

Included
Alu 3
065178

Included
Alu 4
065185

ALU PULLER

051003

4 positions
4 Positionen

Mini Puller
050921

Patins - Pads (x2)
060807

Included
Alu 1
050938

Included
Alu 2
050945

ANNEAUX DE TIRAGE RAPIDE

- Fast pulling rings

058743



x5
058712

Alu 1
050938

Alu 2
050945



Marteau à inertie
380 g
050051

MARTEAUX ALU

- Alu hammers

020986



ALU

ASPIRATEUR PNEUMATIQUE POUR POUSSIÈRES ALUMINIUM (ATEX)

- Pneumatic alu dust atex vacuum cleaner

058866

Capacity : 25 l
Working air pressure : 6 bar
Air consumption at 6 bar : 800 l/min
Suction connection : 50 mm
Max suction capacity : 150 m³/h
Max vacuum level : 2000 mm H₂O
Recommended compressor power : 7.5 HP
↳ 74 x 45 x 45 mm
▲ 18 kg

included
Filtre -
Filter
058873

included
Sac - Bag
5 kg
058880

5 m
Output Ø 29 mm
Input Ø 35 mm



Décapeur thermique

- Heat gun
- Heißluftpistole

I : 100/300°C (450 W)
II : 300/650°C (1500 W)
Air flow : 450 l/min



066311

Pistolet à air chaud autonome à gaz

- Gas hot air gun



060777

Lampe à souder

- Blow torch -
Lötlampe



052741

Novacet +

(Butane/propane/
propylene)
380 ml/220 g



040441

Brosses -

Brushes -
Bürsten -
Brossen -
Cepillos

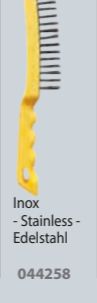

044258

Crayon marqueur

thermique -
Infrared
Thermometer



052765

Thermomètre

infrarouge -
Infrared
Thermometer



052994

Spray refroidisseur

- Freezer spray

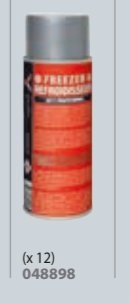

(x 12)
048898

Spray barrière

thermique -
Heat barrier
spray

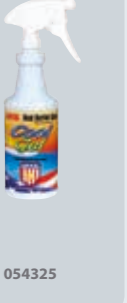

054325

MARTEAUX INERTIE
- Slide hammers - Ausbeulhammer**COMPLETE**
057272**1,1 kg**
049802included (x1)
049482 + included (x20)
052239

Options (x1) 054028 + (x5) 050839

Clous - Nails - Nägel

**1,1 kg**
041813Ø 2, M4 (x1)
049277Ø 2 (x100)
041561MIG/MAG nozzle
for Nail welding
041523

Rondelles - Washers - Ringe

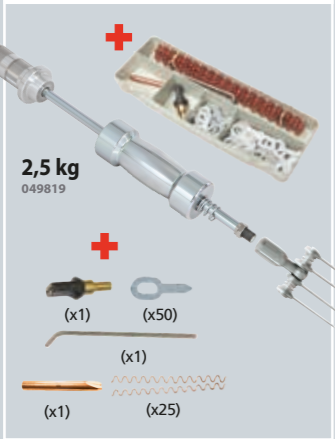
**1,7 kg**
051201Ø 16, 8x16 (x1)
049574(x1)
0512188x16 (x100)
049444**COMPLETE KIT**
051225**2,5 kg**
049819

(x1) + (x50)

(x1) + (x25)

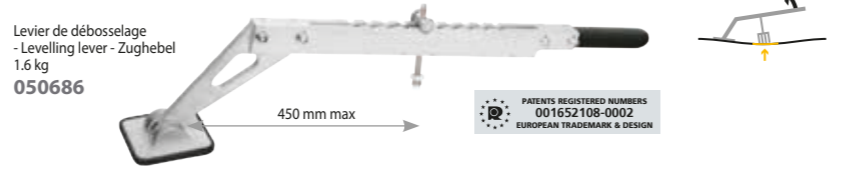
Kit marteau à inertie - Inertia hammer kit
- Ausbeulhammer set**6 kg**
051928**STANDARD**Levier de débosselage
- Levelling lever - Zughebel
1.6 kg
050686

450 mm max

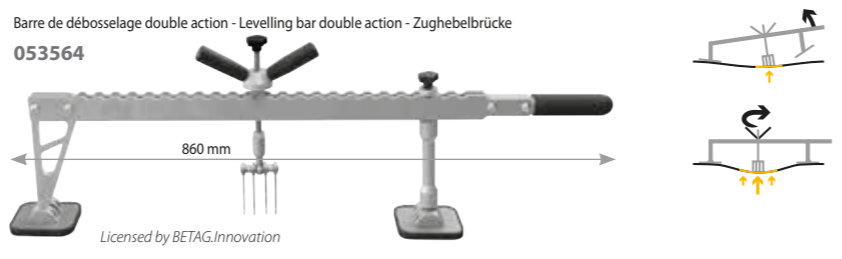
PATENTS REGISTERED NUMBERS
001652108-0002
EUROPEAN TRADEMARK & DESIGNBarre de débosselage double action - Levelling bar double action - Zughebelbrücke
053564

860 mm

Licensed by BETAG.Innovation

Barre de débosselage - Levelling bar - Zugbrücke
3.4 kg
050693

780 mm max

Licensed by BETAG.Innovation

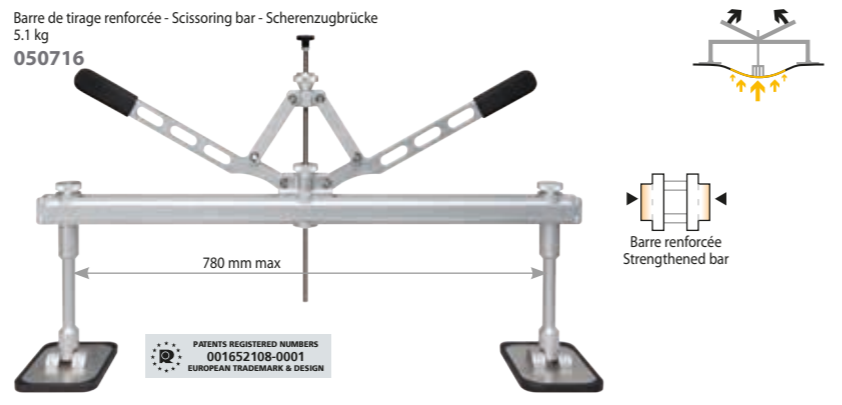
Barre de tirage renforcée - Scissoring bar - Scherenzugbrücke
5.1 kg
050716

780 mm max

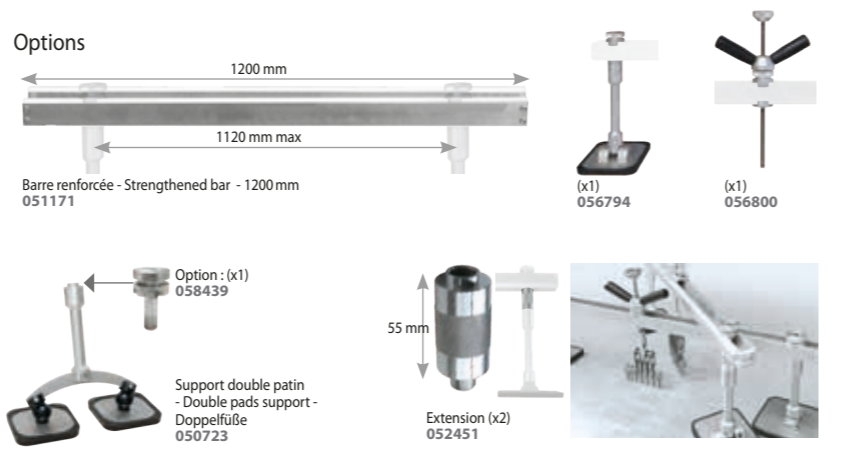
PATENTS REGISTERED NUMBERS
001652108-0001
EUROPEAN TRADEMARK & DESIGNBarre renforcée
Strengthened bar

Options

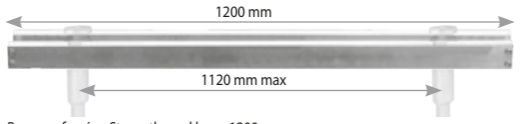
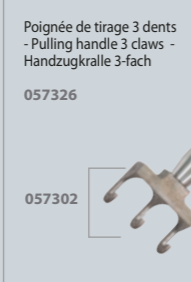
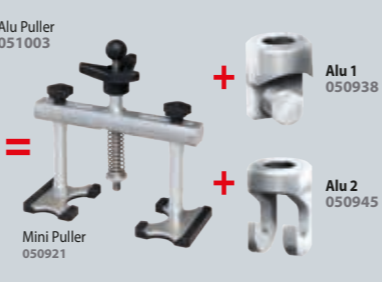
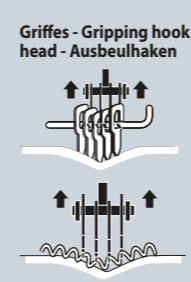
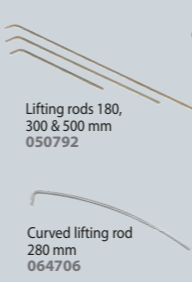
Barre renforcée - Strengthened bar - 1200 mm
051171(x1)
056794(x1)
056800Option : (x1)
058439
Support double patin
- Double pads support -
DoppelfüÙe
050723Extension (x2)
052451Poignée de tirage 3 dents
- Pulling handle 3 claws -
Handzugkralle 3-fach
057326Poignée de tirage 2 dents
057319Alu Puller
051003Alu 1
050938Alu 2
050945Mini Puller
050921Griffes - Gripping hook
head - Ausbeulhaken
057296Lifting rods 180,
300 & 500 mm
050792Curved lifting rod
280 mm
064706

Compatibility:

BASIC

PREMIUM

BASIC

PREMIUM

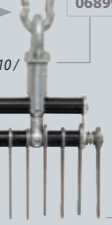
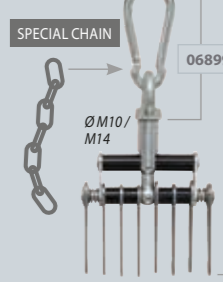
Long pads
needed2-teeth
hook
057296Premium
2-teeth hook
059382Premium
3-teeth hook
059658Ø M10 / M14
049758Ø M10 / M14
049734Ø M10 / M14
049741SPECIAL CHAIN
068995Ø M10 /
M14

067745

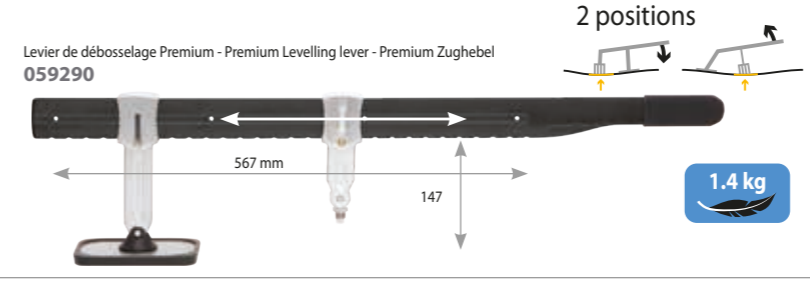
PREMIUMLevier de débosselage Premium - Premium Levelling lever - Premium Zughebel
059290

2 positions

567 mm

147

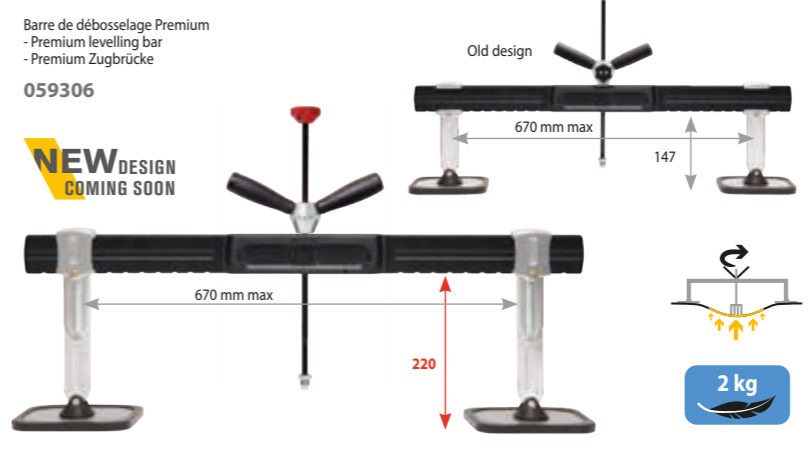
1.4 kgBarre de débosselage Premium
- Premium levelling bar
- Premium Zugbrücke
059306NEW DESIGN
COMING SOON

Old design

670 mm max

147

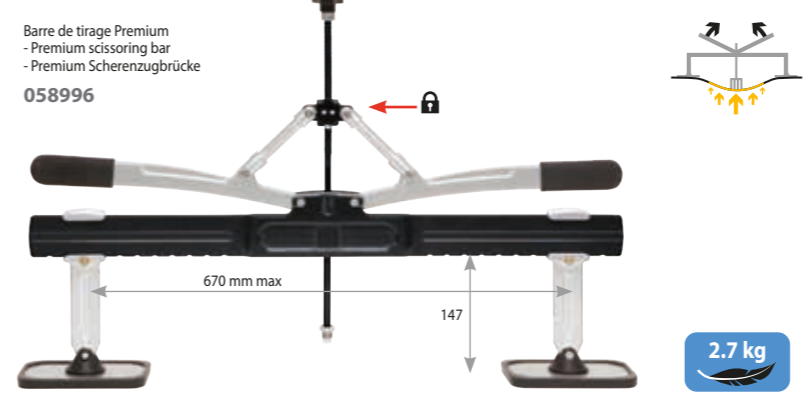
2 kgBarre de tirage Premium
- Premium scissoring bar
- Premium Scherenzugbrücke
058996

670 mm max

147

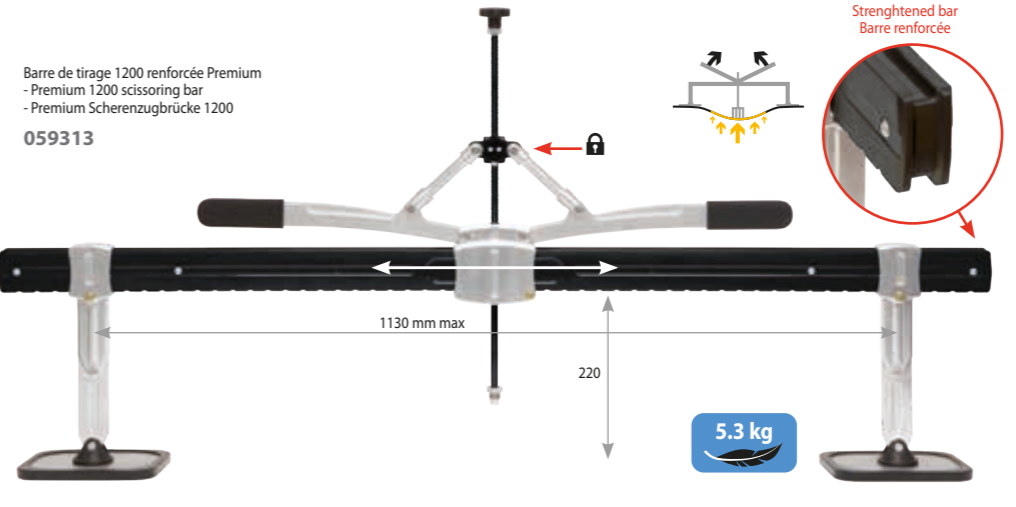
2.7 kgBarre de tirage 1200 renforcée Premium
- Premium 1200 scissoring bar
- Premium Scherenzugbrücke 1200
059313

1130 mm max

220

5.3 kgStrengthened bar
Barre renforcéeArc Puller Premium
065161

Included:

Alu 3
065178Alu 4
065185Patin - Pads
(x2)
069008

NEW

ULTRA LIGHT

ULTRA ERGONOMIC

ULTRA RESISTANT
No deformation

PERFECT BALANCE

Slide & Lock

Full rotation

GRIP

Multi positions

Options

059320

x1 059337

x2 061293

059399

069268

150

220

x1 059344

x2 059351

x1 059368

x2 059375

NEW



CHARIOTS - Trolleys



Compatibility

GYSLOT	Spot 600	Spot 1000	Weld 810	Weld 810 XL	Universal 800	Spot 1600	Dentstation Pro
2600, 2700	✓	✓			✓	✓	✓
34.02/04	✓	✓			✓	✓	✓
3902/04	✓	✓			✓	✓	✓
PRO 230/400	✓	✓			✓	✓	✓
EXPERT 200/230/400	✓	✓			✓	✓	✓
ALU PRO FV	✓				✓	✓	✓
COMBI 230 E PRO			✓			✓	✓
ARCPULL 200/350						✓	✓
ARCPULL 700				✓		✓	✓



DENT PULLING WORKSTATIONS

UNE SOLUTION COMPLÈTE
A COMPLETE SOLUTION
KOMPLETTLÖSUNGEN

EASYLINER

ALL IN 1 BOX

GYSLOT (guns & consumables included) SPOT 1000 053540 Levelling bar double action 053564 + Dent box easy 053632

39.02 053618 GYSLOT 39.02 ✓

PROLINER

GYSLOT (guns & consumables included) UNIVERSAL 800 051331 Cable support 052284 Levelling bar double action 053564 + Dent box bar 050037

39.02 035775 GYSLOT 39.02 ✓

39.04 035782 GYSLOT 39.04 ✓

PRO 230 035799 GYSLOT PRO 230 ✓

PRO 400 035805 GYSLOT PRO 400 ✓

GYSLOT (guns & consumables included) UNIVERSAL 800 051331 Cable support 052284 Alu puller 051003

ALU PRO FV 035836 GYSLOT ALU PRO FV ✓ ✓ ✓

GYSLOT (guns & consumables included) Weld 810 037489 Cable support 052284 Arc puller premium 065161

ARC PULL 200 065260 GYSLOT ARC PULL 200 ✓ ✓ ✓



SPEEDLINER

ALU PRO FV 036055	GYSPOT ALU PRO FV													
39.02 035010	GYSPOT 39.02													
39.04 035027	GYSPOT 39.04													
PRO 230 036017	GYSPOT PRO 230													
PRO 400 036024	GYSPOT PRO 400													
EXPERT 200 028180	GYSPOT EXPERT 200													
EXPERT 230 066984	GYSPOT EXPERT 230													
EXPERT 400 028197	GYSPOT EXPERT 400													
COMBI 230EPRO 036062	GYSPOT COMBI 230 E.PRO	✓	x2											
ARC PULL 200 069015	GYSPOT ARC PULL 200 + PRO 230													
+ PRO 400 069053	GYSPOT ARC PULL 200 + PRO 400													
+ EXPERT 200 065284	GYSPOT ARC PULL 200 + EXPERT 200	✓	x2											
+ EXPERT 230 066991	GYSPOT ARC PULL 200 + EXPERT 230													
+ EXPERT 400 065291	GYSPOT ARC PULL 200 + EXPERT 400													✓
without generator 035058														

SPEEDLINER PREMIUM

ARC PULL 200 065277	GYSPOT ARC PULL 200													
PRO 230 068766	GYSPOT PRO 230													
PRO 400 068773	GYSPOT PRO 400													
EXPERT 200 068780	GYSPOT EXPERT 200													
EXPERT 230 068803	GYSPOT EXPERT 230													
EXPERT 400 068827	GYSPOT EXPERT 400													
COMBI 230EPRO 068841	GYSPOT COMBI 230 E.PRO	✓	x2											
ARC PULL 200 069022	GYSPOT ARC PULL 200 + PRO 230													
+ PRO 400 069060	GYSPOT ARC PULL 200 + PRO 400													
+ EXPERT 200 068797	GYSPOT ARC PULL 200 + EXPERT 200	✓	x2											
+ EXPERT 230 068810	GYSPOT ARC PULL 200 + EXPERT 230													
+ EXPERT 400 068834	GYSPOT ARC PULL 200 + EXPERT 400													✓



✓ ALU PRO FV

SPEEDLINER ALU

- ✓ 39.02, 39.04
- ✓ PRO 230, PRO 400
- ✓ EXPERT 200, EXPERT 230, EXPERT 400

ACIER / STEEL / STAHL



SPEEDLINER PREMIUM ALU + ACIER / STEEL / STAHL

- ✓ COMBI 230 E.PRO
- ✓ ARC PULL 200 + PRO 230
- ✓ ARC PULL 200 + PRO 400
- ✓ ARC PULL 200 + EXPERT 200
- ✓ ARC PULL 200 + EXPERT 230
- ✓ ARC PULL 200 + EXPERT 400

COMPLETE SYSTEM

★ ★ ★



- ✓ COMBI 230 E.PRO
- ✓ ARC PULL 200 + PRO 230
- ✓ ARC PULL 200 + PRO 400
- ✓ ARC PULL 200 + EXPERT 200
- ✓ ARC PULL 200 + EXPERT 230
- ✓ ARC PULL 200 + EXPERT 400

SPEEDLINER ALU + ACIER / STEEL / STAHL



SPEEDLINER PREMIUM ALU

ACIER / STEEL / STAHL

✓ ARC PULL 200

✓ PRO 230, PRO 400
✓ EXPERT 200, EXPERT 230, EXPERT 400



DENTSTATION

	Dentstation Pro 056848 + Fixing kit 051362	Cable support 052284	Manuspot 050679	Ringmatic 052154	Manual pulling handle 057289	Levelling lever 050686 + Levelling bar 050693 + Scissoring bar 050716	Double pads 050723 + Strengthened bar 051171 + Extensions (x2) 052451	Multihook heads 049758 +049734 +049741	3 lifting rods 050792	Dent box consumables 051515	Empty box 320x 113mm	Magnetic earth 049666	Fast pulling rings (x5) 058712 + Alu puller 051003	Arc puller premium 065161	4 m ³ support 059665 + Flanges (x 2) 062146
39.02 028012	GYSPT 39.02					✓									
39.04 028029	GYSPT 39.04														
PRO 230 036420	GYSPT PRO 230														
PRO 400 036437	GYSPT PRO 400														
EXPERT 200 036734	GYSPT EXPERT 200					✓									
EXPERT 230 067028	GYSPT EXPERT 230														
EXPERT 400 036741	GYSPT EXPERT 400														
COMBI 230 E.PRO 036444	GYSPT COMBI 230 E.PRO	✓	x2			✓							✓		
ARC PULL 200 + PRO 230 069039	GYSPT ARC PULL 200 + PRO 230														
+ PRO 400 069077	GYSPT ARC PULL 200 + PRO 400														
+ EXPERT 200 065321	GYSPT ARC PULL 200 + EXPERT 200	✓	x2			✓									✓
+ EXPERT 230 067035	GYSPT ARC PULL 200 + EXPERT 230														
+ EXPERT 400 065338	GYSPT ARC PULL 200 + EXPERT 400														

DENTSTATION PREMIUM

	Dentstation Pro 056848 + Fixing kit 051362	Cable support 052284	Manuspot 050679	Ringmatic 052154 + Manual pulling handle 057289	Manual pulling handle 057289 + Premium levelling lever 059290 + Premium levelling bar 059306 + Premium scissoring bar 058996 + Premium levelling lever 1200 059313	Premium double pads support 150 mm 059351 + 220 mm 059375	Hook head 049734 + 059658 + 059382	3 lifting rods 050792	Dent box consumables 051515 + Empty box 320x 113mm	Magnetic earth 049666	Fast pulling rings (x5) 058712 + Alu puller 051003	Arc puller premium 065161	4 m ³ support 059665 + Flanges (x 2) 062146
PRO 230 028067	GYSPT PRO 230												
PRO 400 028074	GYSPT PRO 400												
EXPERT 200 036758	GYSPT EXPERT 200					✓							
EXPERT 230 067042	GYSPT EXPERT 230												
EXPERT 400 036765	GYSPT EXPERT 400												
COMBI 230 E.PRO 036772	GYSPT COMBI 230 E.PRO	✓	x2			✓							
ARC PULL 200 + PRO 230 069046	GYSPT ARC PULL 200 + PRO 230												
+ PRO 400 069084	GYSPT ARC PULL 200 + PRO 400												
+ EXPERT 200 065345	GYSPT ARC PULL 200 + EXPERT 200	✓	x2			✓							✓
+ EXPERT 230 067059	GYSPT ARC PULL 200 + EXPERT 230												
+ EXPERT 400 065352	GYSPT ARC PULL 200 + EXPERT 400												



✓ 39.02, 39.04
✓ PRO 230, PRO 400
✓ EXPERT 200, EXPERT 230, EXPERT 400

DENTSTATION ACIER / STEEL / STAHL

COMPLETE SYSTEM



✓ COMBI 230 E.PRO
✓ ARC PULL 200 + PRO 230
✓ ARC PULL 200 + PRO 400
✓ EXPERT 200 + ARC PULL 200
✓ EXPERT 230 + ARC PULL 200
✓ EXPERT 400 + ARC PULL 200

DENTSTATION ALU + ACIER / STEEL / STAHL



✓ COMBI 230 E.PRO
✓ ARC PULL 200 + PRO 230
✓ ARC PULL 200 + PRO 400
✓ EXPERT 200 + ARC PULL 200
✓ EXPERT 230 + ARC PULL 200
✓ EXPERT 400 + ARC PULL 200

DENTSTATION PREMIUM ALU + ACIER / STEEL / STAHL



✓ PRO 230, PRO 400
✓ EXPERT 200, EXPERT 230, EXPERT 400

DENTSTATION PREMIUM ACIER / STEEL / STAHL

DRAW ALIGNER**PULLING SYSTEMS****DRAW ALIGNER**

Équerre de tirage - Draw aligner - Schnellausbeul-Richtausleger 052475

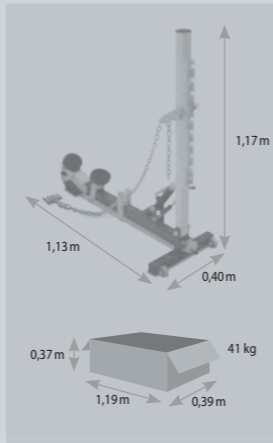
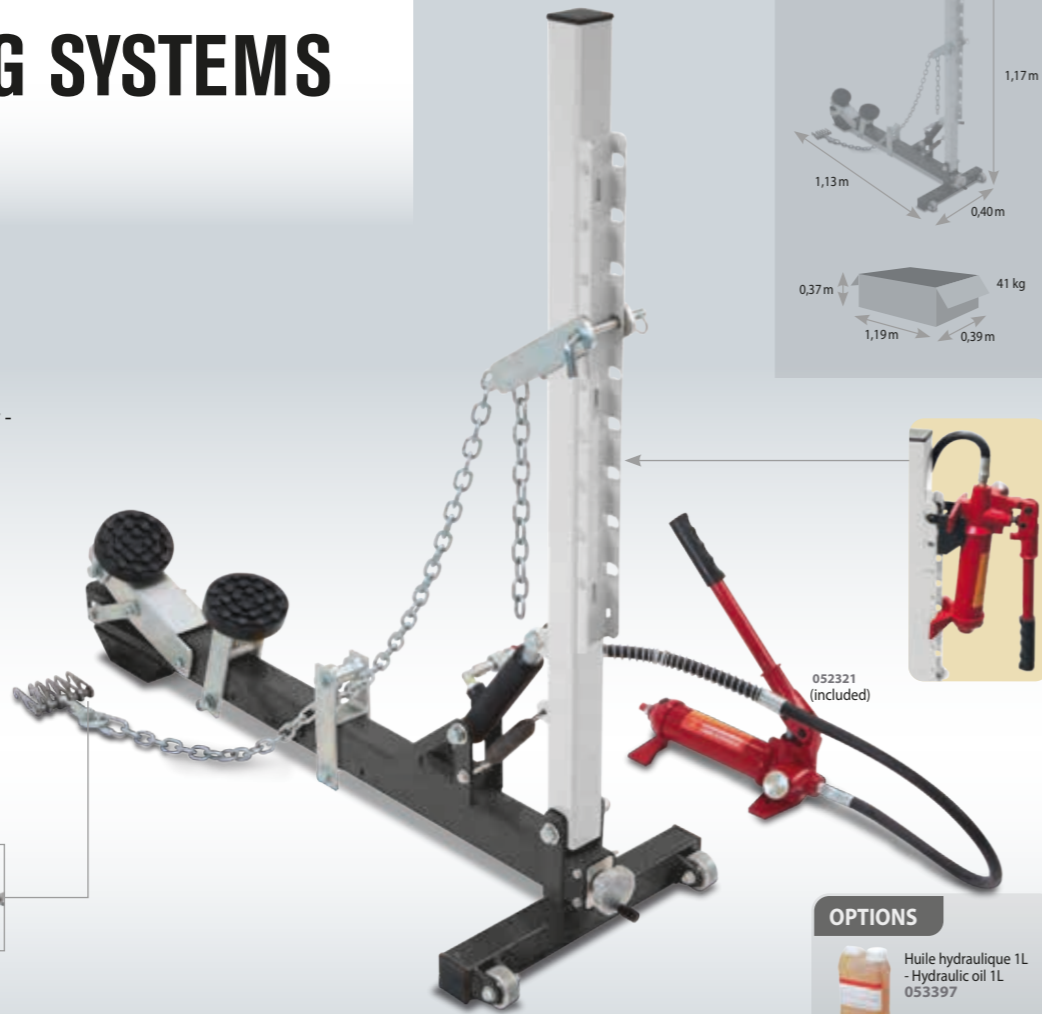
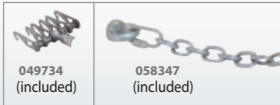
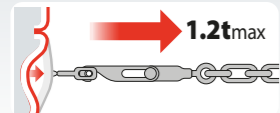
**OPTIONS****INCLUDED**

Câle pour bas de caisse - Wedge for rocker panel

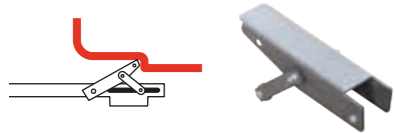

Kit patins pour bas de caisse - Pads kit for rocker panel

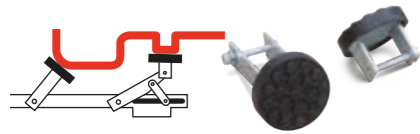
**OPTIONS**

Bras de bas de caisse - Rocker panel arms for draw aligner - Abstütztraverse für Richtausleger

052581

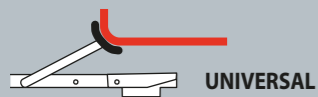
**UNIVERSAL**

7 kg

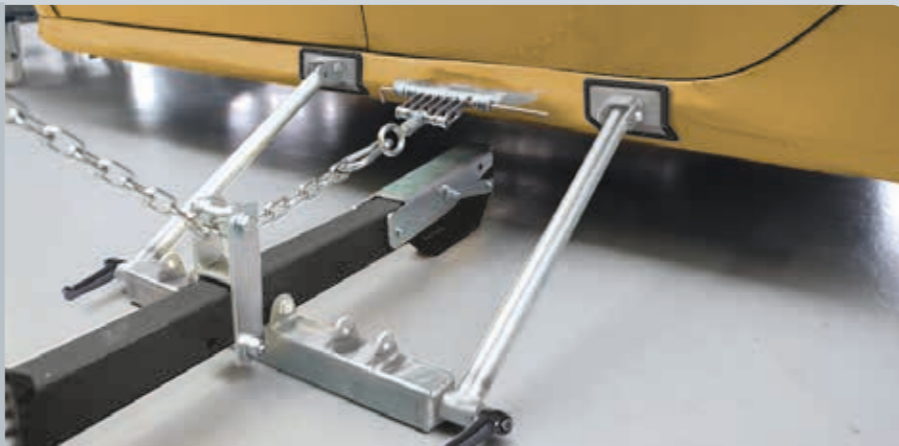
**Débosselage déporté****DRAW ALIGNER PRO**

069244

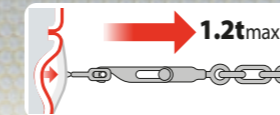

049734 (included)

058347 (included)

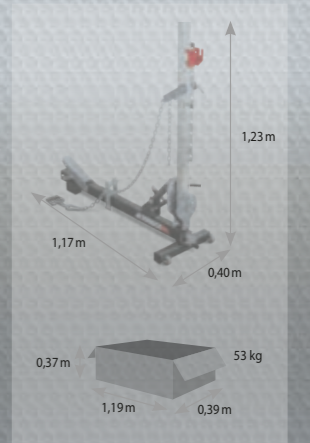
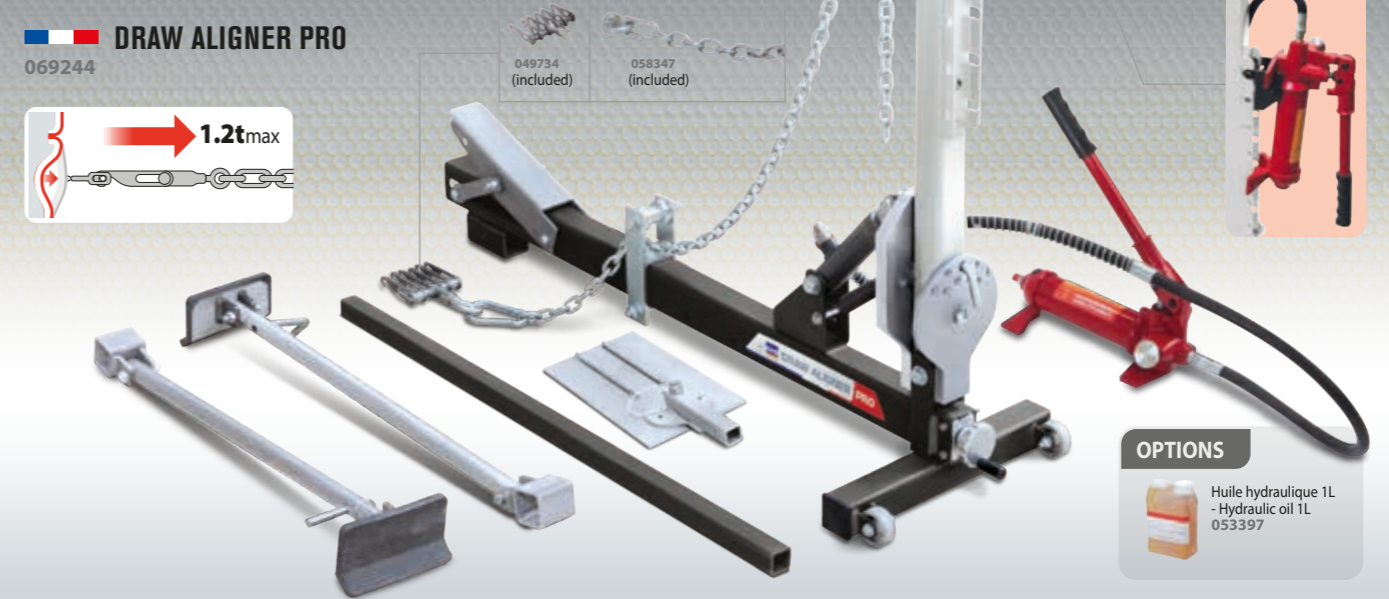
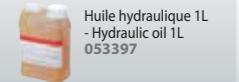
**OPTIONS****INCLUDED**

Câle sous roue - Plate under the wheel

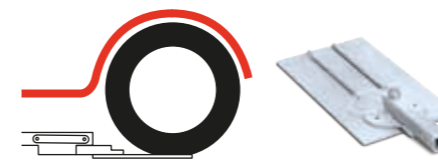

Câle pour bas de caisse - Wedge for rocker panel

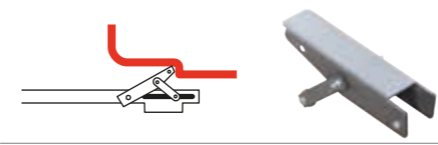

Kit bras de bas de caisse et barre de stabilisation - Rocker panel arms and stabilisation bar

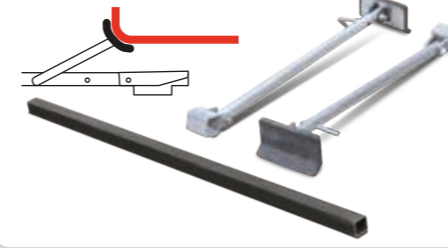
**OPTIONS**

Kit patins pour bas de caisse - Pads kit for rocker panel 071278



SYSTÈME DE TIRAGE SMART PULLER SILVER

- Smart puller silver pulling system - Schnellausbeul-Richtausleger Smart puller silver

054820

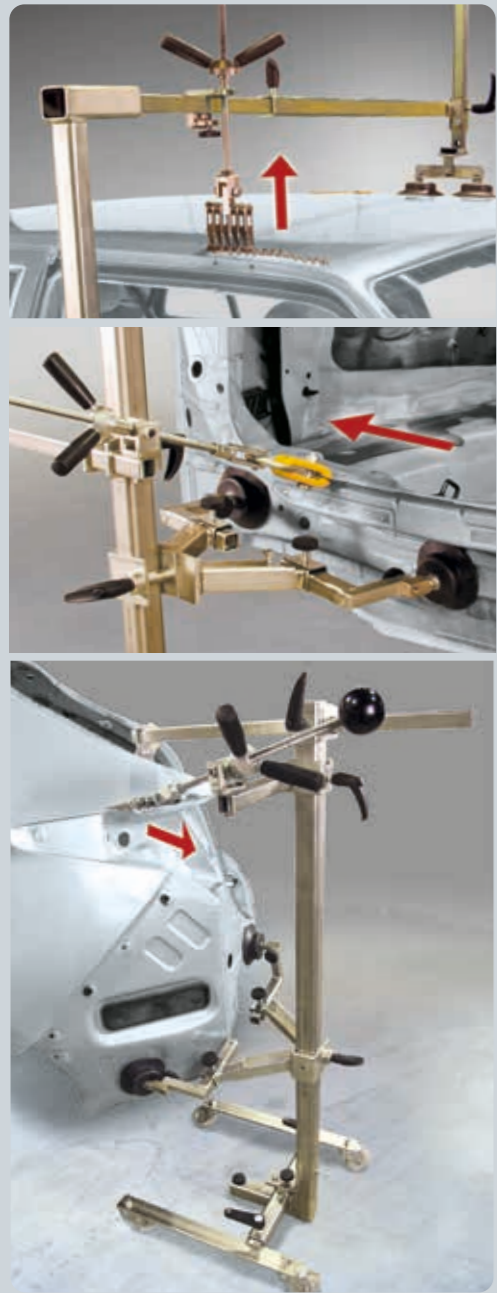

- Portières - Doors - Türen
- Montants - Supports - Scheibenrahmen
- Capot - Hood/Bonnet - Haube
- Armature - Armature - Rahmen
- Bas de caisse - Rocker panel - Schweller
- Ailes - Wings - Kotflügel
- Toit - Roof - Dach
- Hayon - Hatchback - Heckdeckel

min : 0,60 m
max : 2,00 m

min : 1,50 m
max : 2,70 m

0,55 m

0,20 m

1,55 m

0,35 m

54 kg

Autorobot

INCLUDED

Accessories



Youtube

ELECTRO POWER - Zug-Druckpresse

Non commercialisable en France

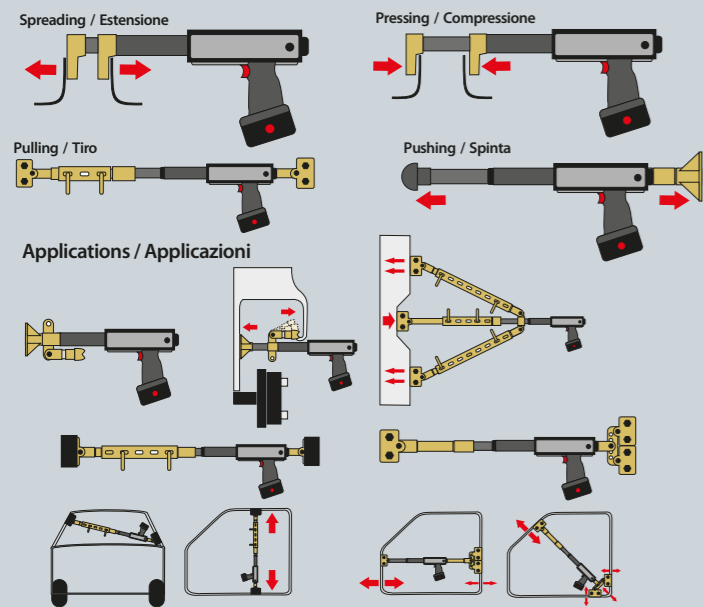

with accessories : 057425

PULLING POWER: 5 Ton.
PUSHING POWER: 5 Ton.
PISTON STROKE: 130 mm



MADE IN ITALY



Standard kit : 425x620x210 mm
Standard kit Total weight: 18 kg
057401

Li-Ion battery (included) 058514



Accessories kit : 425x620x150 mm
Accessories kit Total weight: 20 kg
057418

COFFRET VÉRIN HYDRAULIQUE - Hydraulic cylinder kit - Hydraulischer Drucksatz

MADE IN P.R.C.

BASIC 4T
052345



BASIC 10T
052338

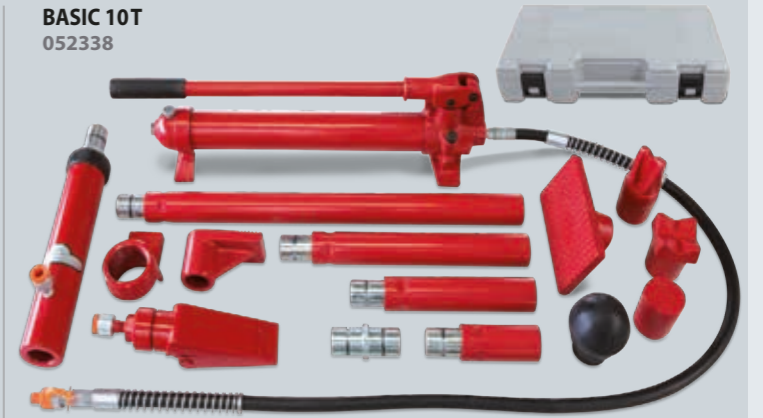

PRO 4T
057432



PRO 10T
057449



OPTIONS

Huile hydraulique 1L
- Hydraulic oil 1L
053397

BARRE D'ANCRAGE - Anchor bar - Türspanner

MADE IN TAIWAN

053045



910 > 1130 mm

053052



1540 > 1930 mm



MESURES - Measuring tools - Vermessung

BODYMETER, Mechanical measurements

052130

250 > 2230 mm

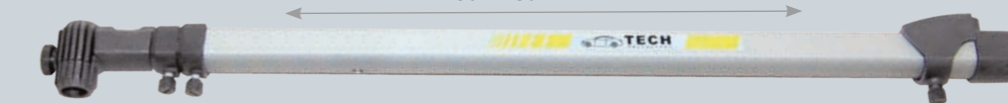

GYSMETER, Electronic measurements

052093

Measuring report

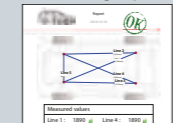

Light weight measuring arm with an easy to read digital display

400 > 2650 mm



PINCE PIVOTANTE
- Swivel clamp

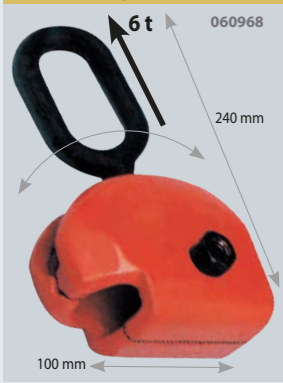

PINCES DE TIRAGE - Frame Straightening - Ziehwerkzeuge

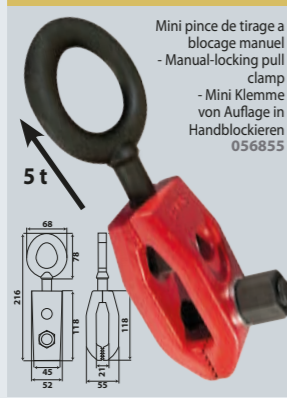

CROCHET DE TIRAGE - Frame Straightening - Ziehwerkzeuge

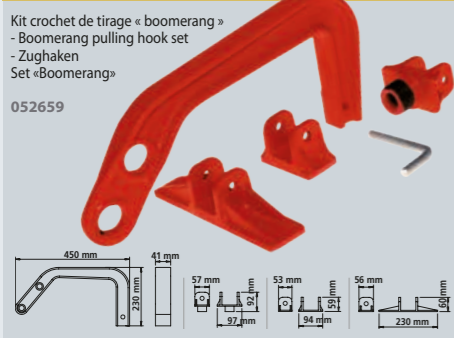

PASSAGE DE ROUE - Arch hooks

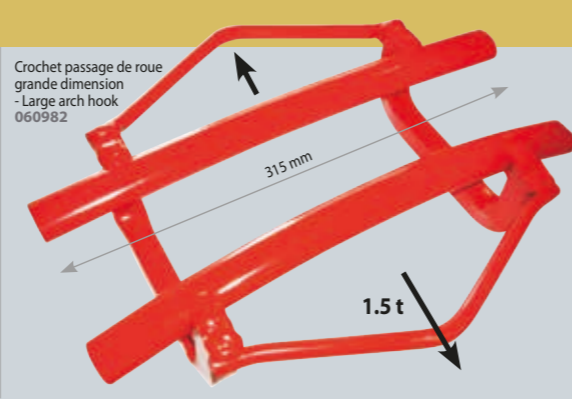
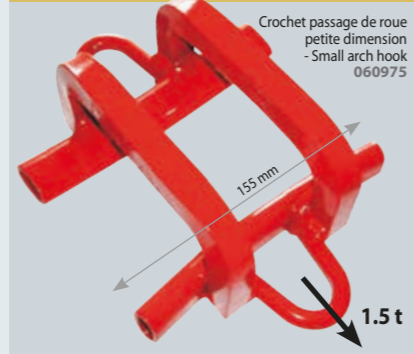

CHAÎNES DE TIRAGE - Frame Straightening - Ziehwerkzeuge

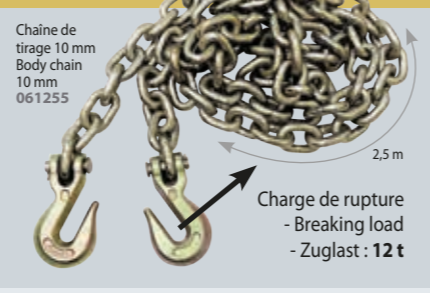
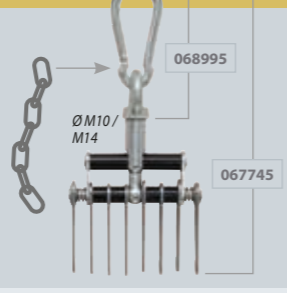
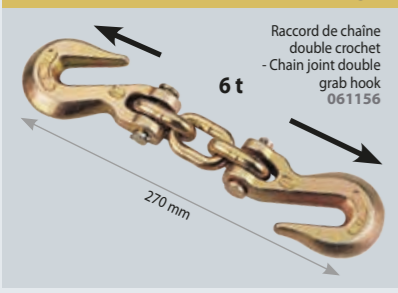

PINCES DE TIRAGE LARGES - Wide pull clamps

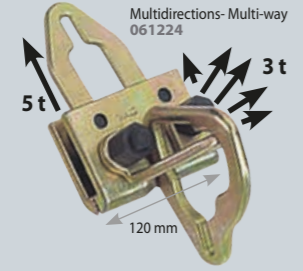

PINCES DE TIRAGE FAIBLE LARGEUR - Small pull clamps

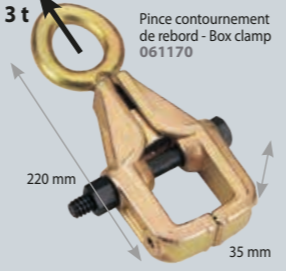
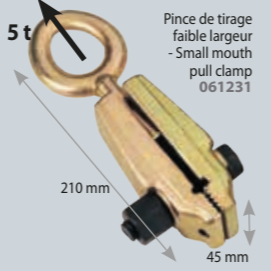
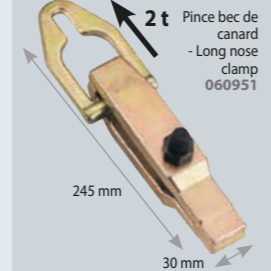

PINCE DE TIRAGE MULTIPLE - Multiple pull clamp

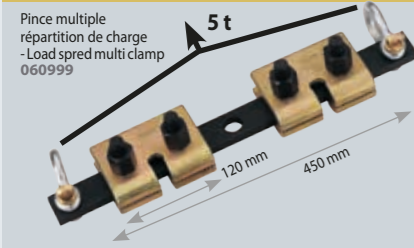

PINCE CISEAUX LARGEUR - 45 mm - 45 mm scissors clamp

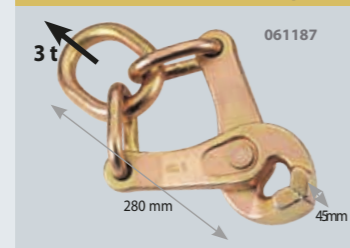

PINCE DE TIRAGE POUR ANGLE 90° - 90 Degree corner clamp



PINCE DE TIRAGE TYPE C - C type clamp



KIT MARTEAU À INERTIE - Inertia hammer kit - Ausziehhammer kit

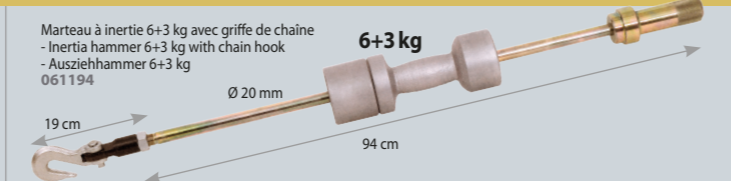
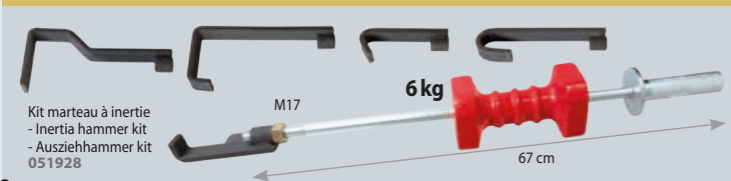

SATELLITE INTELLIGENT - Smart Satellite - Satellit Komplett-Kit

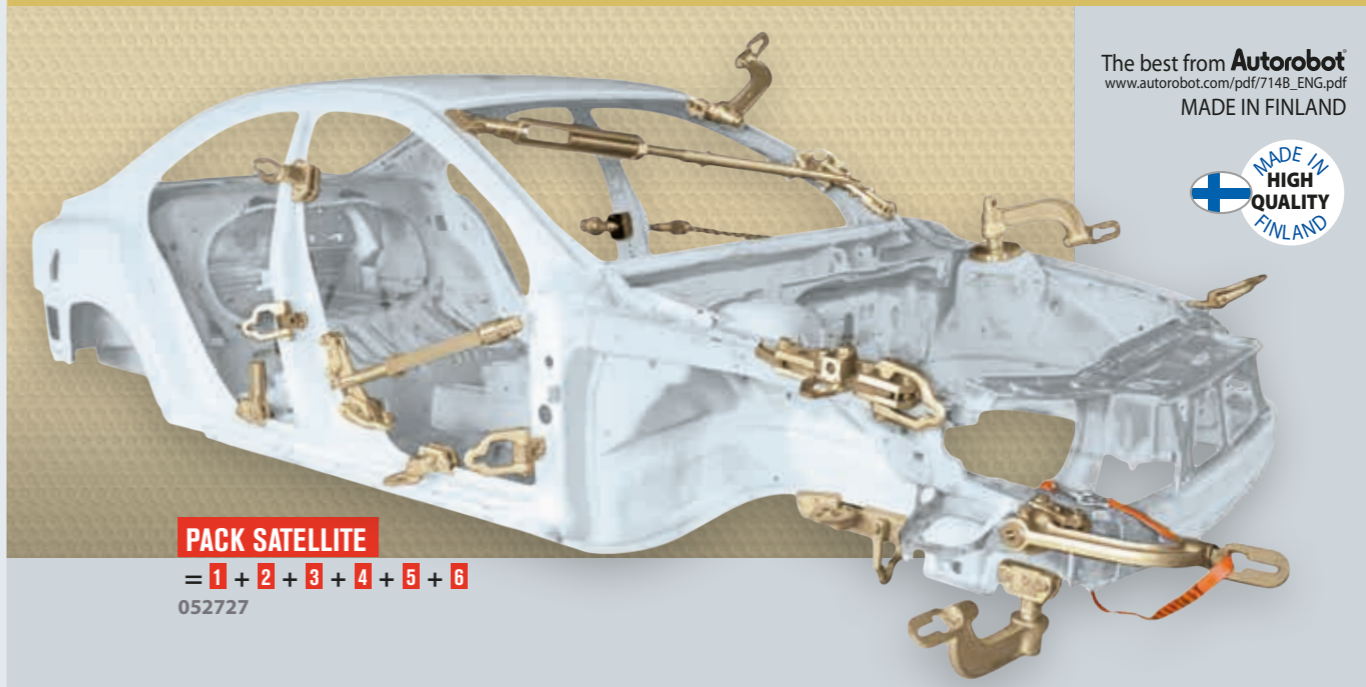

PACK SATELLITE
= 1 + 2 + 3 + 4 + 5 + 6
052727

1 SATELLITE
- Satellite - Satellit Basisbügel-Set



2 KIT MAC PHERSON (A)
- Mac Pherson Kit - Befestigungskit-Federbein (McPherson)

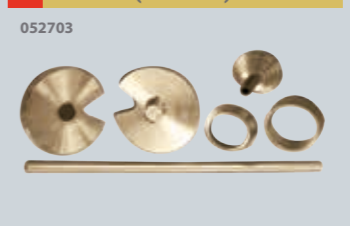

3 BARRE POUR TIRER/POUSSER
- Push/Pull Bar - Zug/Druck-Stangenset

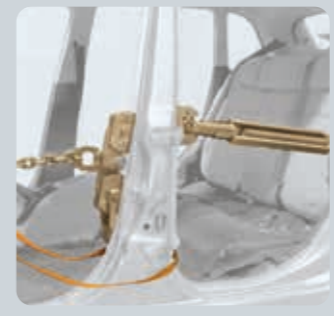
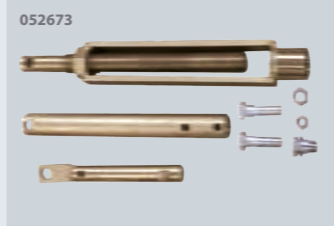

4 SATELLITE (B)
- Bügelverlängerung

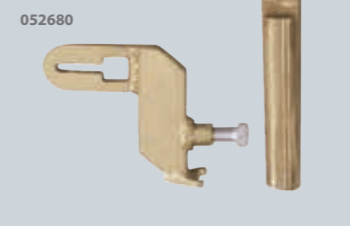

5 SANGLE DE SÉCURITÉ
- Safety Strap - Sicherungsgurt



6 DOUBLE PINCE SATELLITE (C)
- Double Clamp Satellite - Satellit Doppelklemme



PINCE DE TIRAGE MULTI-USAGE
- Versatile pulling clamp - Multifunktions-Zugklemme

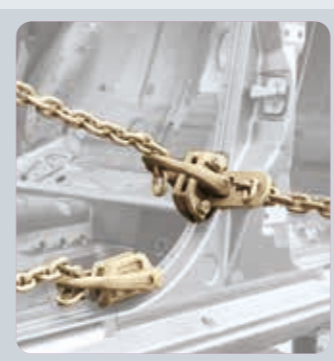

POWER-PULLER 4T





Débosselage rapide et sans peinture
- PDR: Paintless Dent Repair
- Lackschadenfreies Ausbeulen

PAINTLESS DENT REPAIR



Youtube



MADE IN FRANCE

	+	+	Freq.	INTEGRATED TECHNOLOGY	Liquid Cooling	Cable (m)		
50 Hz	A	W	kHz	PFC FV		Inductor	cm	kg
230V, 1~	16	2.400	35+120	■ ■	—	2 2,5	22 x 36 x 27	7,5

OPTION
Spray refroidisseur - Freezer spray -50 °C 400 ml (x 12) 048898

INDUCTEUR DÉBOSSÉLAGE - Dent Pulling Inductor - Dellenmatrix

GYSDUCTION AUTO DENT REPAIR 054981 = GYSDUCTION AUTO + Dent pulling inductor 054776



Licensed by BETAG.Innovation

INSPECTION CARROSSERIE - Dent Pulling Inductor - Ausbeul Induktor

Planche flexible pour inspection de la carrosserie - Ausbeul-Matrix Ø800mm

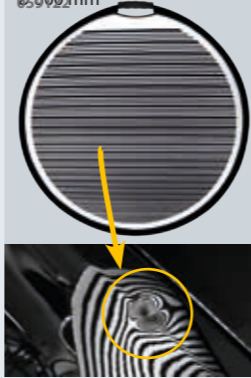

KIT MAGNÉTIQUE DE DÉBOSSÉLAGE SANS PEINTURE - Paintless Dent Repair magnetic kit - Magnetisches Ausbeul-Kit

053168

EXELTOOLS

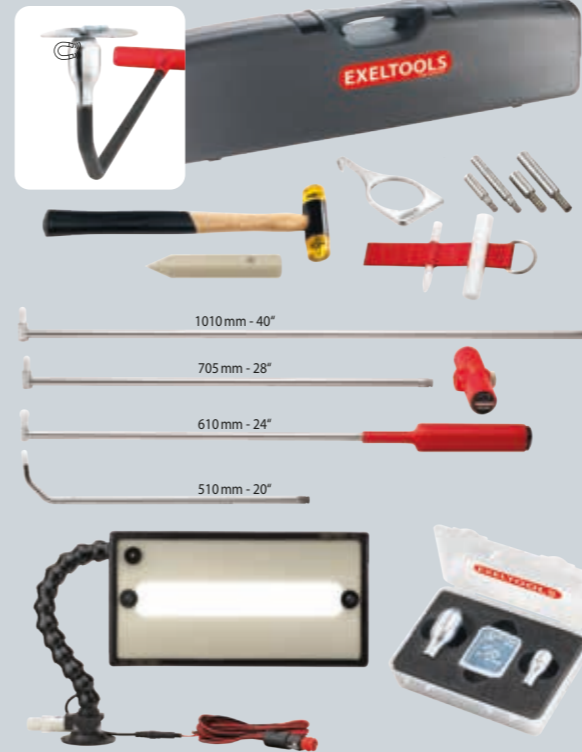

LAMPES DE DÉBOSSÉLAGE - Paintless Dent Repair lamps - Ausbeullampe

056749
Made in Taiwan

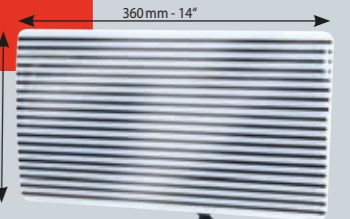

ULTRA LIGHT CARBON X40 PW EXELTOOLS 053175



GLUE PULLER PRO (Acier/Alu - Steel/Alu)



MADE IN FRANCE

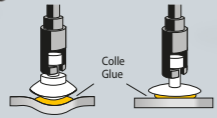

Glue Lifter 057364

Glue Puller PRO 058699

Glue Puller PRO EXPORT 230V 059160 110V 071056

x6 050952



250W 230V 052901 110V 071056



x10 050976



050983



BARRETTES ANNEAUX PLASTIQUE - Plastic Multipads Ösen-Klebe pads

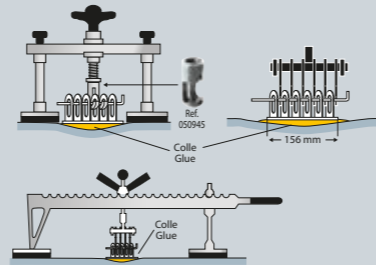
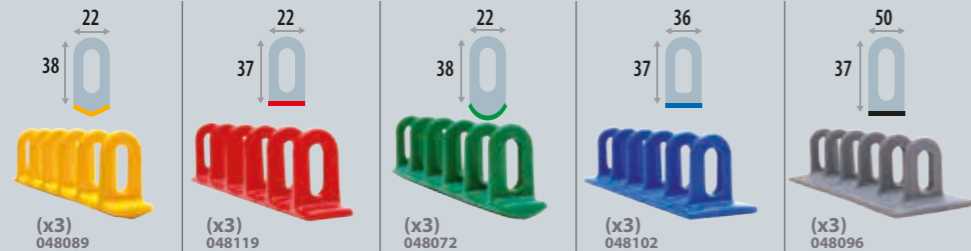

OPTIONS

Poignée de tirage 3 dents - Pulling handle 3 claws - Handzugkralle 3-fach 057326



Marteau à inertie 380g - Slide hammer 380g - Gleithammer 380g 050051

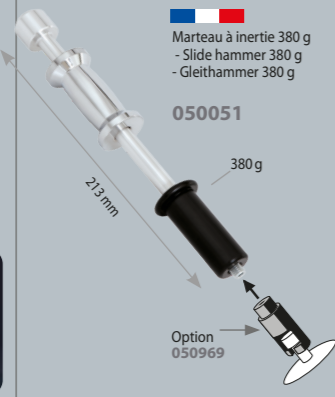

Marteau à inertie 500g - Slide hammer 500g - Gleithammer 500g 057906

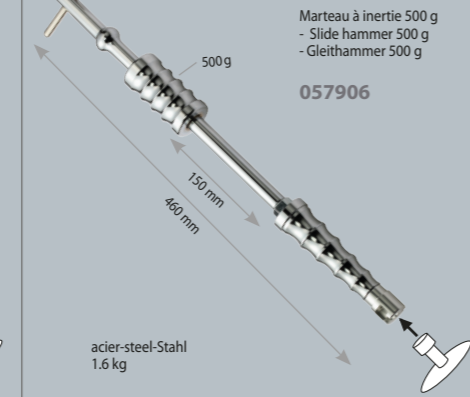

Jeu de 2 couteaux pour découpe de renforts collés - Set of 2 knives to cut glued reinforcements - 2-er Set Messer zur Klebepadentfernung 057913



KIT DÉBOSSÉLAGE SANS PEINTURE - Dent Pulling Kit (paintless) - Dellenausbeulhebel-Set

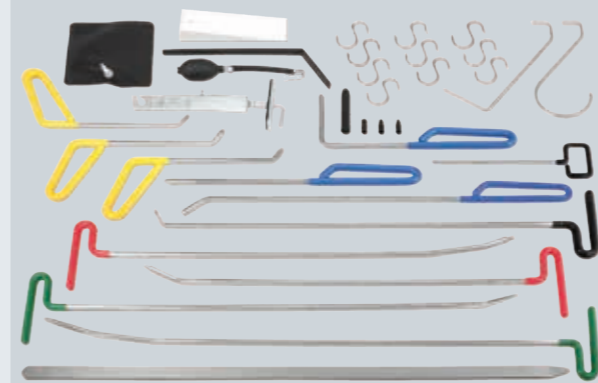

33 parts

051959



KIT DE 6 COINS DE FRAPPE - Set of 6 pencil punches - Beulenstemmer-Satz mit 6 Tefloneinsätzen



MADE IN FRANCE

MARTEAU INERTIE PNEUMATIQUE - Pneumatic inertia hammer - Unterdruck-Schlaghammer

051904

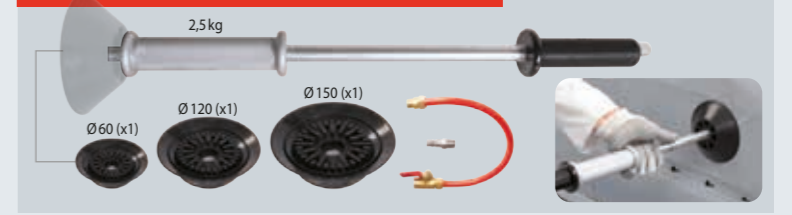

OPTIONS

Poignée de tirage 3 dents - Pulling handle 3 claws - Handzugkralle 3-fach 057326



Marteau à inertie 380g - Slide hammer 380g - Gleithammer 380g 050051

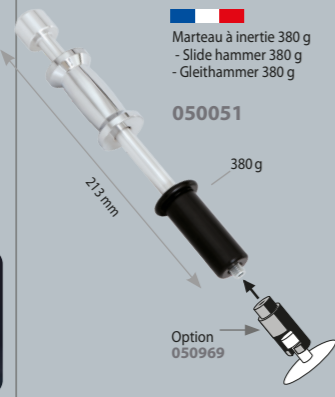

Marteau à inertie 500g - Slide hammer 500g - Gleithammer 500g 057906

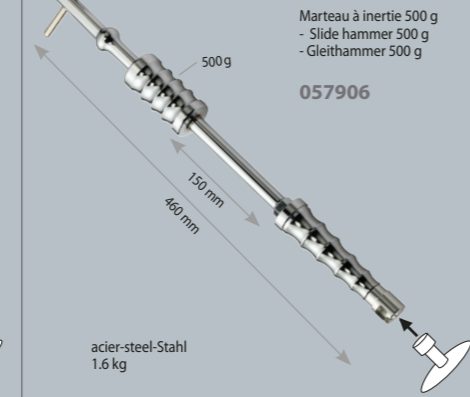

Jeu de 2 couteaux pour découpe de renforts collés - Set of 2 knives to cut glued reinforcements - 2-er Set Messer zur Klebepadentfernung 057913



KIT COUSSINS GONFLABLES - Air Cushion Kit - Luftpolster-Spreizkissen-Satz



MARTEAU À INERTIE À VENTOUSES (POMPAGE MANUEL) - PUMP AIR SUCTION SLIDE HAMMER - Man. Unterdruck-Schlaghammer





SPOT LIFT

MOBILE LIFTS

SPOT LIFT EASY

max Air 8 bar **SAFE EN 1494**
max 2.2 t

HEALTH CARE



Haute stabilité - High stability



Included 220 bar 053588

NEW

SAFE EN 1494

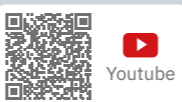

OPTIONS

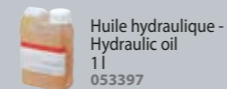

Huile hydraulique - Hydraulic oil 1 l 053397

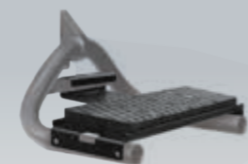

Outil de levage pour bas de caisse - Rocker panel lifting tool - Auflage für Seitenschweller 053236



SPOT LIFT PRO

max Air 8 bar **SAFE EN 1494**
max 2.2 t

053557

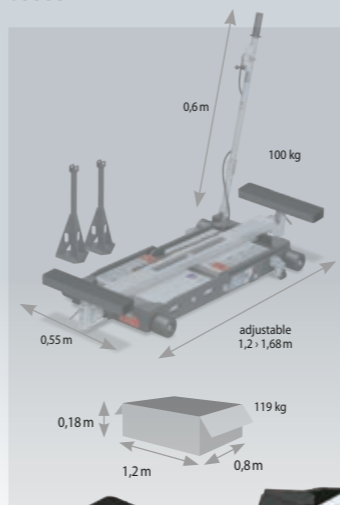

OPTION



SAFE EN 1494

60 cm (max) 14 cm (min)

SPOT LIFT PRO MOB

max Air 8 bar **SAFE EN 1494**
max 2.2 t

055896



SAFE EN 1494

60 cm (max) 14 cm (min)

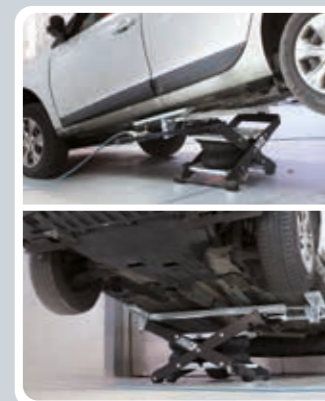

OPTIONS

Réhausseur pour 4x4 et utilitaires - Height adjuster for 4x4 & utility vehicles - Erhöhung f. 4x4 und Leicht-LKW



Patins - Pads for Audi & BMW (x 2) 053717

Rampes - Ramps 700 x 200 x 80 mm (x 2) 056787



OPTIONS

SPOT LIFT PRO MOB Réhausseur pour 4x4 et utilitaires - Height adjuster for 4x4 & utility vehicles - Erhöhung f. 4x4 und Leicht-LKW



Patins - Pads for Audi & BMW (x 2) 061606

Rampes - Ramps 700 x 200 x 80 mm (x 2) 056787

AUTO ROLL

min 500 mm max 1700 mm (AUTOROLL 1.0m) max 2240 mm (AUTOROLL 1.55m) 360° 2.5 t max

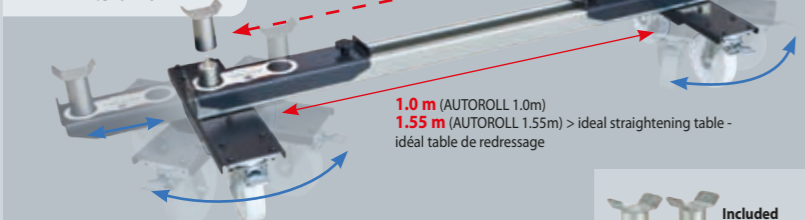

AUTO ROLL 1.0 m / 1.2 t 059047



AUTO ROLL 1.55 m / 1.2 t 063839

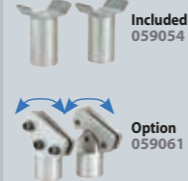

AFTER LIFT AUTO ROLL

1 2 360° 2.5 t max

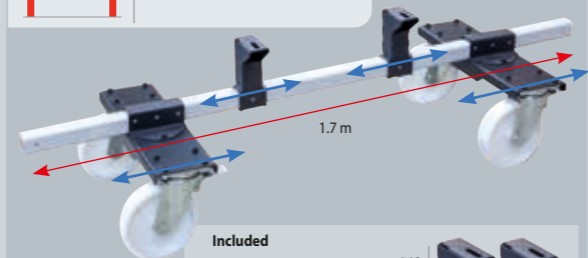

067967 45 Kg

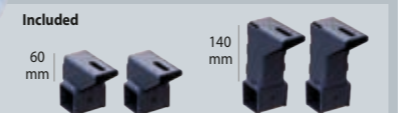

TABOURETS DE MANUTENTION - Wheel trolleys - Radhocker

048768



26 cm max

650 kg max

CHARIOTS DE MANUTENTION PRISE SOUS ROUE - Wheel trucks - Kfz-Montagelift, fahrbar

Chariots mécaniques (x 2) - Mechanic jacks (x 2) 064126

NEW

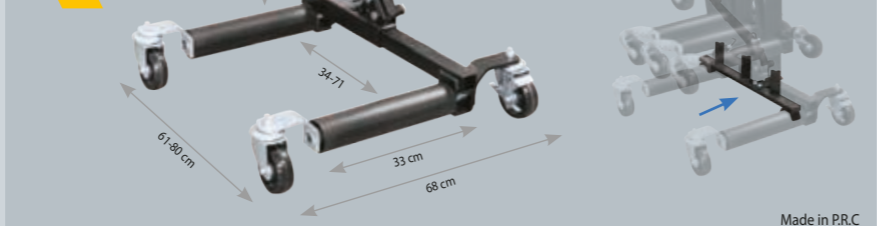

(2x) 15 kg 680 kg max



Option Support - Stand 064133

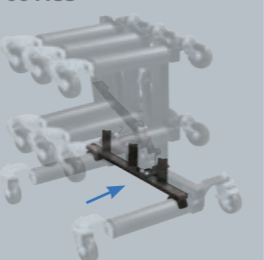

Made in P.R.C



35

SPOT LIFT

MOBILE LIFTS

ERGO LIFT 650

220 V, 1~ **SAFE EN 1493**

max 2 t

056817



Youtube

220 V, 1 ph
0,75 kW

Included
Huile hydraulique -
Hydraulic oil
5l
062160



Pack ERGO LIFT 650
+ 4 Wheel trolleys (x4)

068544

NEW



x4



TROLLEY IW1

max 6.5 bar

6.5 bar

063136



Youtube



Liberté de mouvement
- High dexterity

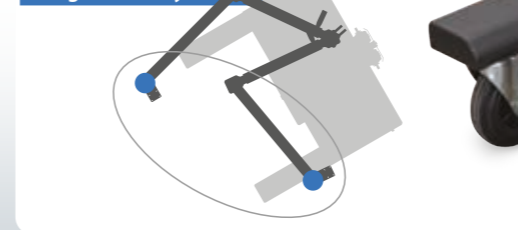

Grande maniabilité et stabilité
- High maneuverability & stability



OPTIONS

Huile hydraulique
- Hydraulic oil
1l
053397

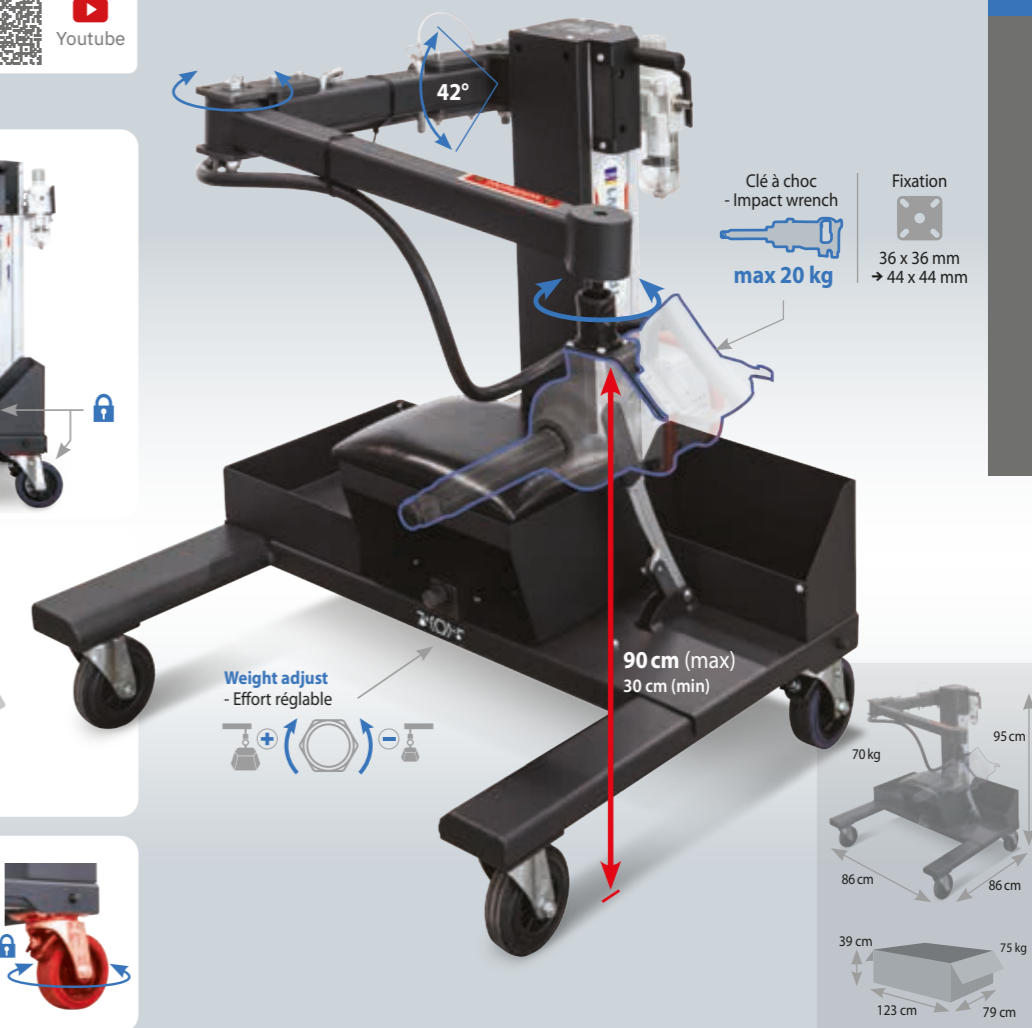

QUICK LIFT L520E

062184

220 V, 1 ph
0,75 kW

Included
Huile hydraulique -
Hydraulic oil
5l
062160

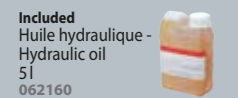

Youtube

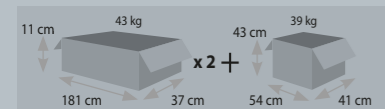

Made in China

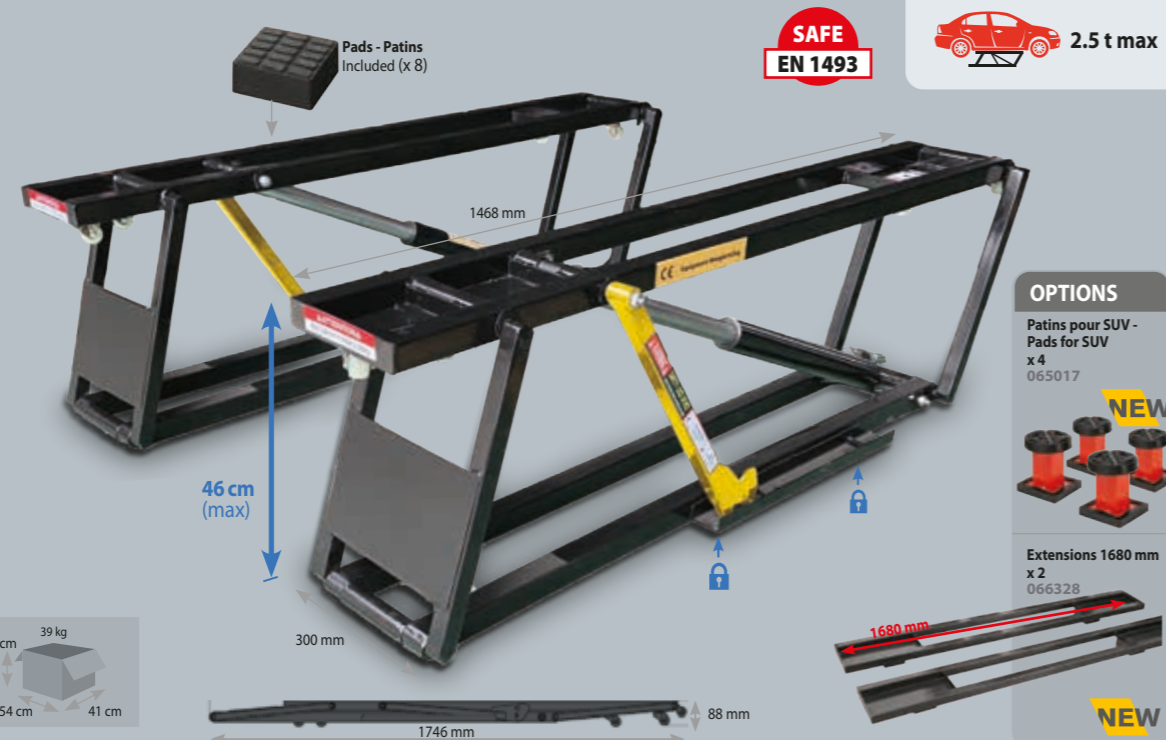

AIR JACKS



AIR JACK VAN 2T
058330

2T max

49 cm max
20.5 cm min

17 kg

AIR JACK CAR 2T
058323

2T max

32.6 cm max
13.2 cm min

14 kg

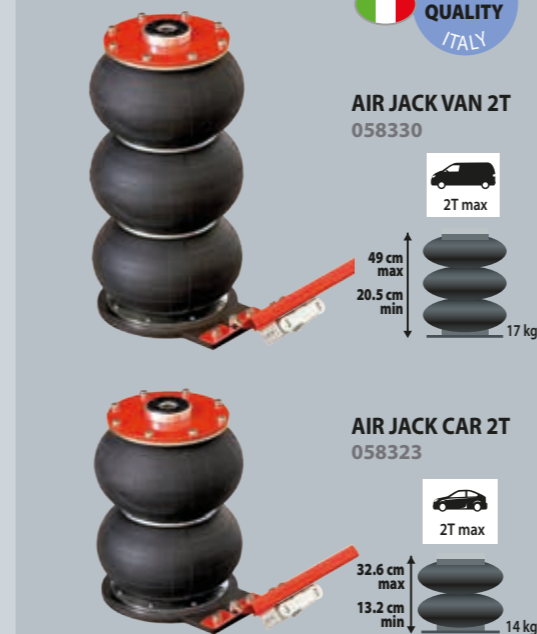

MANUAL WHEEL LIFT

Lève roue à treuil
- Wheel lift trolley
- Radmontage-Heber
061385

min : R13 / 135 / 65
max : R22 / 300 / 35
40 kg max

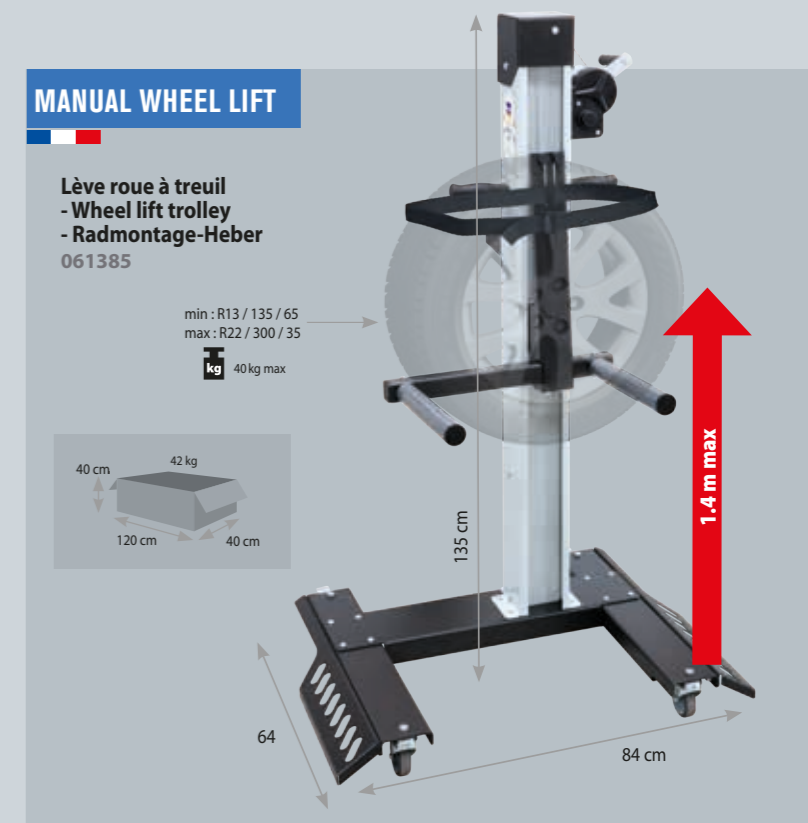
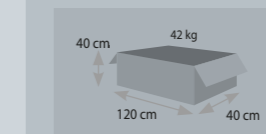

ÉVOLUTION TECHNOLOGIQUE

TECHNICAL IMPROVEMENTS - TECHNISCHE ENTWICKLUNG - MEJORAS TECNICAS

2004
 Facteurs d'évolution :
 • Challenge CO2 = faible poids
 • Crash test = ★★★★★
 • Anti corrosion = nouveaux revêtements
 • Esthétique et visibilité plus sophistiquées.

OLD SOLUTIONS
 Traditional machines
 180 daN max
 6 500 A max
 X clamps
 Ø 4 mm max

2022
 Entwicklungsfaktoren :
 • CO2 Challenge = geringes Gewicht
 • Crash-Test = ★★★★★
 • Anti-Korrosion = neue Beschichtung
 • Modernes Technik-Design.

GYS SOLUTIONS
 INVERTER Technology
 550 daN max
 14 500 A max
 X & C clamps
 Liquid cooled system
 Ø 10 mm

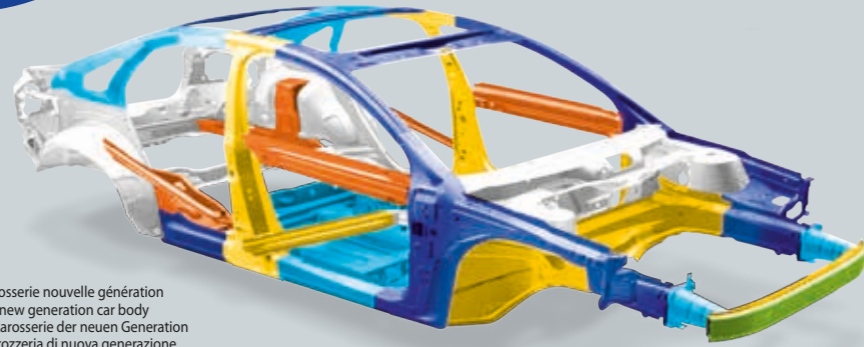
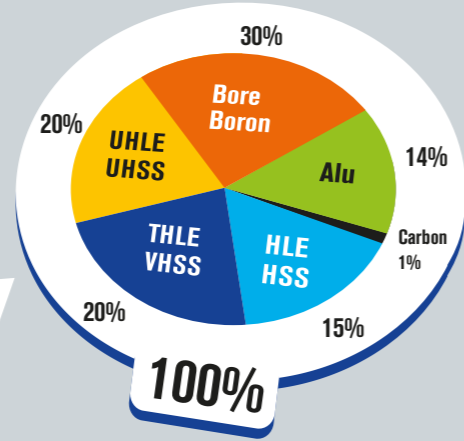
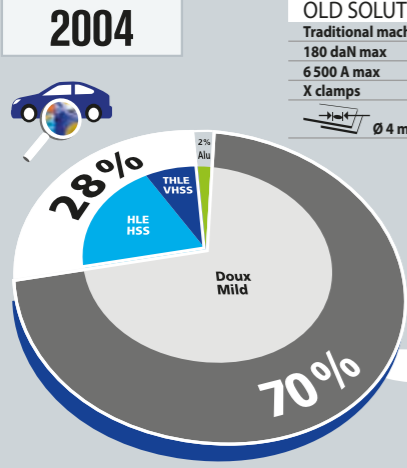

- Mild - Doux
- HSS - HLE
- VHSS - THLE
- UHSS - UHLE
- Bore - Boron
- Aluminium

Exemple de carrosserie nouvelle génération
 • An example of new generation car body
 • Beispiel einer Karosserie der neuen Generation
 • Esempio di carrozzeria di nuova generazione

HOMOLOGATIONS PRODUITS

MANUFACTURER APPROVALS / COMPLIANCE - PRODUKT HOMOLOGATIONEN - PRODOTTI APPROVATI



Product	VW	Jeep	Mercedes	Renault	GM	Volvo	Tata	Other
GYSPT 2600/2700	•	•	•	•	•	•	•	•
GYSPT 39.02/04, PRO230/400, EXPERT 200/400	•	•	•	•	•	•	•	•
PROLINER/SPEEDLINER/DENTSTATION	•	•	•	•	•	•	•	•
GYSPT ALU FV	•	•	•	•	•	•	•	•
ARCPULL 200	•	•	•	•	•	•	•	•
GYSPT 32D	•	•	•	•	•	•	•	•
GYSPT INVERTER 100R	•	•	•	•	•	•	•	•
GYSPT INVERTER BP-LX	•	•	•	•	•	•	•	•
GYSPT INVERTER BP-LC-s7	•	•	•	•	•	•	•	•
GYSPT INVERTER BP-LCX-s7	•	•	•	•	•	•	•	•
GYSPT INVERTER BP-LG	•	•	•	•	•	•	•	•
GYSPT EVOLUTION PTI-s7	•	•	•	•	•	•	•	•
VAS 821 101 - Spot Welder	•	•	•	•	•	•	•	•
GYS PRESS 10T	•	•	•	•	•	•	•	•
T1 GYS AUTO	•	•	•	•	•	•	•	•
T3 GYS AUTO	•	•	•	•	•	•	•	•
AUTOPULSE 220-M3	•	•	•	•	•	•	•	•
AUTOPULSE 320-T3	•	•	•	•	•	•	•	•
VAS 821 005 - Pulse MIG Welder	•	•	•	•	•	•	•	•
VAS 821 00580 023	•	•	•	•	•	•	•	•
EASYCUT 40	•	•	•	•	•	•	•	•
CUTTER 25K/35KF	•	•	•	•	•	•	•	•
CUTTER 30FV/45CT	•	•	•	•	•	•	•	•
GYSDUCTION AUTO	•	•	•	•	•	•	•	•



RANGE



	32 D	100 R	BP / BP-LG	PTI	PTI-G
Doux - Mild	•	•	•	•	•
HLE/THLE - HSS/VHSS	Difficult	•	•	•	•
UHLE/BORE - UHSS/BORON	Difficult	Difficult	•	•	•
Nombre de points - Number of spots 10 spots/min	100	150	no limit	60	no limit
	5	10	95	> 200	
Inverter Technology	—	•	•	•	•
EMF Directive 2013/35/UE	—	—	BODY PROTECT TECHNOLOGY	•	•
Système de refroidissement - Cooling system	AIR	AIR	LIQUID	LIQUID	LIQUID
Régulation automatique - Automated regulation	irregular	constant	constant	constant	constant
MODE AUTO	—	—	• (LC, LG)	•	•
Pince - Clamp	X, C, X+C	• (32DX), • (32DC)	• (100R-X), • (100R-C), • (100R-CX)	• (BP.LX), • (BP.LC, BP.LG)	•
Transformer Inside Clamp	—	—	—	•	•
Cables (L)	2,5 m	2,5 m	2,5 m	4 or 6 m	6 m
Includes gun	•	•	•	option	option
Cadence de soudage maximale (points/min) - Max welding frequency (spots/min)	10	10	BP-LC : 10 - BP-LG : 20	10	20
	6	10	2	6	10
Fuse	400 V	32 A	40 A	32 A	40 A
	200/208-240 V	—	—	—	—
		60 A	80 A	100 A	40 A
				20 A	25 A
				40 A	50 A

BP BODYPROTECT TECHNOLOGY
 2013/35/UE
 UNIQUE ELECTRO-MAGNETIC FIELD PROTECTION by GYS

LA SOLUTION GLOBALE - THE GLOBAL SOLUTION

®BODY PROTECT is a proprietary GYS technology that minimises electromagnetic fields created by the machine.
 Compliant : Directive 2013/35/UE
 Certified by : Laboratory EMITECH
 MADE IN FRANCE

Other technologies vs GYS BODYPROTECT TECHNOLOGY

B1	10 < 25 cm (Norm : 3 cm max)	B1	0 cm (Norm : 3 cm max)
B2	25 < 35 cm (Norm : 30 cm max)	B2	5 cm (Norm : 30 cm max), 4 cm (Norm : 30 cm max)
B3	35 cm (Norm : 20 cm max)	B3	0 cm (Norm : 20 cm max)
B4	35 cm (Norm : 20 cm max)	B4	0 cm (Norm : 20 cm max)

SPOT WELDING

PORTASPOT 230
6 300 A 120 daN
 Air cooled

230V
022256

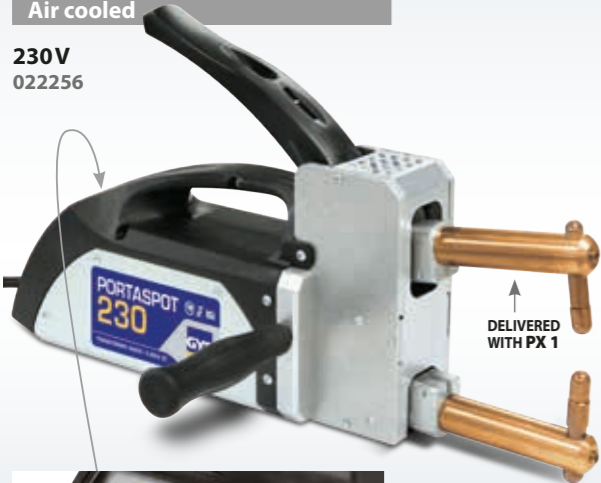

DELIVERED WITH PX 1



ARMS Ø 23 mm

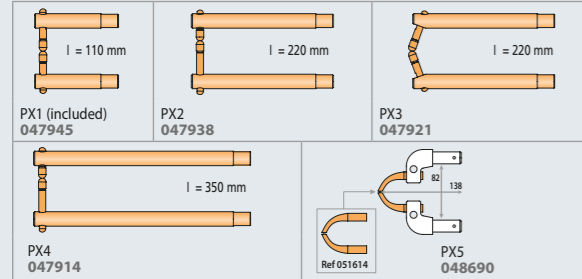

ELECTRODES

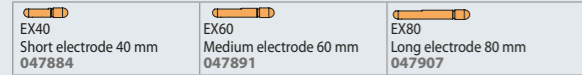

CAPS & ACCESSORIES

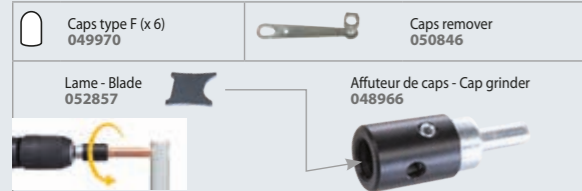

50/60 Hz	A	A	A	mm	V	m	mm ²	100% CU	(no arm) cm	kg
1 x 230V	16(D)	6 300	8 900	2+2	2,45	2,5	3x2,5 H05VVf	OK	36x29 x10	10

GYSPOT 32D-X
7 500 A 500 daN
 Air cooled
 2 x 400V
 019881



GYSPOT 32D-C
7 500 A 300 daN
 Air cooled
 2 x 400V
 019898



GYSPOT INVERTER 100R-X
10 000 A 500 daN
 For mild steel, HSS, UHSS
 Air cooled
 Traceability software
 Save spot welding configuration and export data
 3 x 400V
 019911



GYSPOT INVERTER 100R-C
10 000 A 300 daN
 For mild steel, HSS, UHSS
 Air cooled
 Traceability software
 Save spot welding configuration and export data
 3 x 400V
 019928



GYSPOT INVERTER 100R-CX
10 000 A 500 daN (X)
 300 daN (C)
 For mild steel, HSS, UHSS
 Air cooled
 Traceability software
 Save spot welding configuration and export data
 3 x 400V
 022317



OPTIONS

050068
 x10 (x20: 052239)
 x6 (x6: 049994)
 x18 (x6: 049987)
 x18 (x6: 049970)

Housse de protection - Protection cover - Schutzhaube 052260

NEW
 Kit WIFI for 100R-X/C/CX 070691

RC4 8 bar/120 daN, for 32D-C, 100R-C & 100R-CX 052253

048935
 x40 (x6: 049987)

051614

INCLUDED

Model	019881	019898	019911	019928	022317
32D-X	■	■	■	■	■
32D-C	■	■	■	■	■
100R-X	■	■	■	■	■
100R-C	■	■	■	■	■
100R-CX	■	■	■	■	■

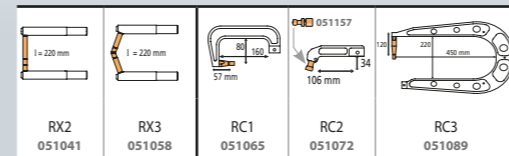
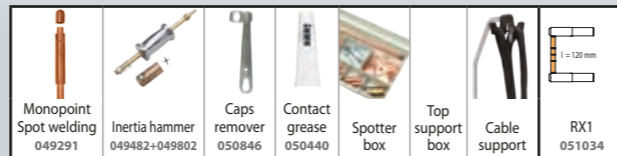

Model	051041	051058	051065	051072	051089
32D-X	■	■	■	■	■
32D-C	■	■	■	■	■
100R-X	■	■	■	■	■
100R-C	■	■	■	■	■
100R-CX	■	■	■	■	■

Country	50/60 Hz	A	A	A	mm	U _o	Cables		100% CU	kg
							Air Cooled	mm ²		
MADE IN FRANCE	50/60 Hz	16(D)	6 300	8 900	2+2	2,45	2,2	200	OK	55 x 75 x 190
							2,5	150		
CE MARK	50/60 Hz	16(D)	6 300	8 900	2+2	2,45	2,5	200	OK	70 x 99 x 208
							2,5	150		
CE MARK	50/60 Hz	16(D)	6 300	8 900	2+2	2,45	2,5	200	OK	95.5
							2,5	150		

GYSPOT INVERTER AIR COOLED

GYSPOT INVERTER BP-LX
13 000 A
 550 daN

For mild steel, HSS, UHSS **Boron steel**

Double pressure
 Ø 10 mm
 6,5 kg (included X1)

Liquid cooled

BP BODYPROTECT
 Unique electro-magnetic field protection
 2013/35/UE by GYS

Traceability software
 Save spot welding configuration and export data

019652

	019652	058804
400V		
Gyspot BP-LX	▪	▪
Monopoint/Spot 049291	▪	▪
Spotter box pro (p.10) 050075	▪	▪
Inertia hammer 049482 + 049802	▪	▪
X1 050501	▪	▪
X4A (x2) + X4B + X4C + X2 020733	▪	▪
Liquid cooling (10l) 052246		(x3)

Included Support haute stabilité
 -High stability support
 Compatible gyro +



GYSPOT INVERTER BP-LC-s7
13 000 A
 550 daN

For mild steel, HSS, UHSS **Boron steel**

Double pressure
 Ø 10 mm
 6,5 kg (included C1)

Liquid cooled

BP BODYPROTECT
 Unique electro-magnetic field protection by GYS

EDC Automatic C clamp
 Energy Dynamic Control

Traceability software
 Save spot welding configuration and export data

020757

	020757	058798
400V		
Gyspot BP-LC-s7	▪	▪
Monopoint/Spot 049291	▪	▪
Spotter box pro (p.10) 050075	▪	▪
Inertia hammer 049482 + 049802	▪	▪
Contact grease 050440	▪	▪
Caps remover 050846	▪	▪
Arm panel	▪	▪
C1 019140	▪	▪
C2 + C3 + C4 019126	▪	▪
C6 019775	▪	▪
Liquid cooling (10l) 052246		(x3)

GYSPOT INVERTER EVOLUTION PTI
14 500 A
 550 daN

For mild steel, HSS, UHSS **Boron steel**

FUSE 16>25 A
 Double pressure
 Ø 10 mm
 9,9 kg (included C1)

TRANSFORMER INSIDE

Liquid cooled

EDC Automatic C clamp
 Energy Dynamic Control

Traceability software
 Save spot welding configuration and export data

020894

	4M 022188	4M 020894	4M 067998
	6M 022195	6M 020900	
220V		400V	
Gyspot Evolution PTI	▪	▪	▪
Contact grease 050440	▪	▪	▪
Caps remover 050846	▪	▪	▪
Arm panel	▪	▪	▪
C1 021402	▪	▪	▪
C2 + C3 + C4 021457	▪	▪	▪
C6 019775	▪	▪	▪
Gyro 360° 051720	▪	▪	▪
Complete gun kit 067318	▪	▪	▪
Liquid cooling (10l) 052246			(x3)

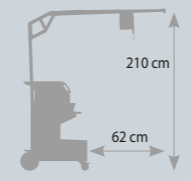

Very light
 9,9 kg



OPTION



OPTIONS

050068 x10 (x20: 052239) x18 (x6: 049987)
 x6 (x6: 049994) x18 (x6: 049970)

048935 x40 (x6: 049987)

NEW SD CARD 050914
 Kit WIFI 070691

Liquide de refroidissement Cooling liquid Kühlmittel Enfrimiento líquido Refrigeração líquida 052246

Housse de protection - Protection cover - Schutzhaube for BP & PTI 050853

OPTIONS BP-LC

GYRO 360° for BP-LC 051737

MADE IN FRANCE 62135	50/60 Hz	A D curve	Spots/min (max) ± 2.5+2.5	RMS A	Uo V	mm			Cables		100% CU	cm	kg
						↕	↔	↔	↔	↔			
GYSPOT BPLX	3 x 400V	32 (22 kVA) 40 (28 kVA) 50 (35 kVA)	2 6 10	13 000	16	2.5+2.5+2.5	1,5+3	2.5, liquid	2.5	8 m, 4x6 H07RN-F	OK	65 x 80 x 205	150
GYSPOT BPLC-s7	3 x 400V	16 (11 kVA) 20 (14 kVA) 25 (17 kVA)	10	11 500 14 500	8	2.5+2.5+2.5	1,5+3	4 m, liquid		8 m, 4x4 H07RN-F	OK	65 x 80 x 230	91
GYSPOT EVOLUTION PTI-s7	3 x 200V 208V 220V 240V	30 (10-12 kVA) 40 (14-16 kVA) 50 (17-21 kVA)	10	12 500 13 000 14 500 14 500	6,95 7,2 8 8,3	2.5+2.5+2.5	1,5+3	4 m, liquid		OPTION 067318: 1.6 m, Ø 200 mm² 8 m, 4xAWG8 (SOOW)	OK	65 x 80 x 230	91

FOR GYSPOT 32D-X, 100R-X, BP-LX, BP-LCX**550 daN****6,5 kg** including X1

- DOUBLE PRESSURE
- LIQUID COOLED / REFRIGERATION LIQUIDE
- Ø 10 mm

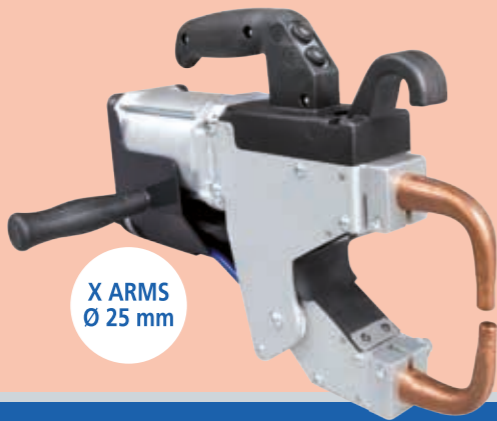
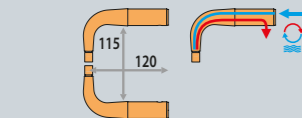
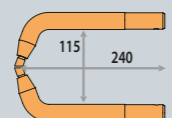
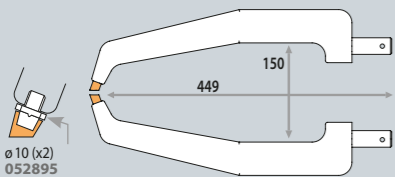
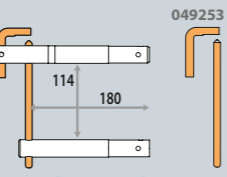
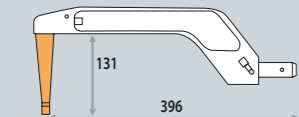
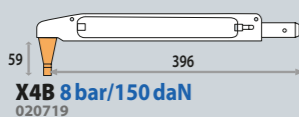
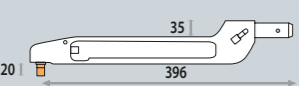
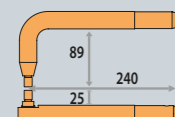
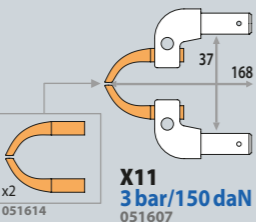
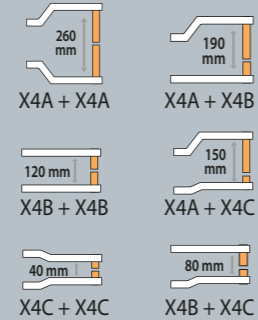
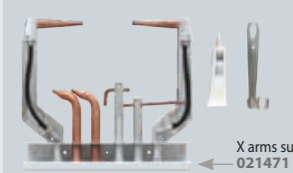
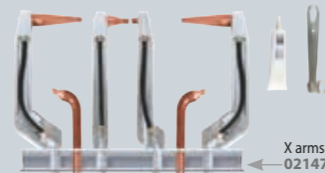
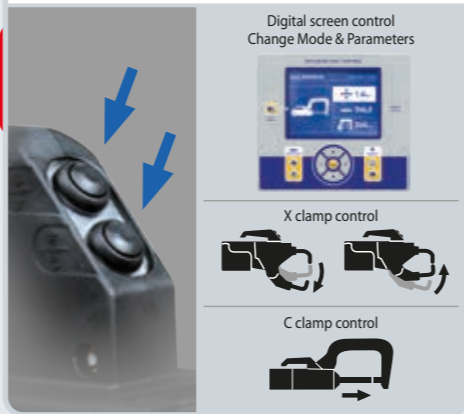

MADE IN FRANCE

X ARMS
Ø 25 mm**X Arms - Caps Ø13 mm****X1 8 bar/550 daN**
050501**X2 8 bar/400 daN**
050518**X4 8 bar/120 daN**
050532**X5 8 bar/200 daN**
050549**X4A 8 bar/150 daN**
020702**X4B 8 bar/150 daN**
020719**X4C 8 bar/150 daN**
020726**X6 8 bar/400 daN**
050587**X4 (A, B & C) combinations****X ARMS PANELS****X4A (x2) + X5 + X2**
022324X arms support
021471**X4A (x2) + X4B + X4C + X2**
020733X arms support
021471**Remote control (BP)****C ARMS PANELS**

- C2
- + C3
- + C4

 019126

- C2
- + C3
- + C4

 021457

- C2
- + C3
- + C4

 060821

- C2 + C3 + C6 + C12
- = 061286
- C2 + C3 + C6 + C12 + C9
- = 061316

FOR GYSPOT BP-LCX, BP-LC, PTI**550 daN****6,5 kg** including C1

- DOUBLE PRESSURE
- LIQUID COOLED / REFRIGERATION LIQUIDE
- Ø 10 mm



MADE IN FRANCE



Youtube

550 daN**Transformer inside****9,9 kg** including C1

- DOUBLE PRESSURE
- AIR COOLED + LIQUID COOLED / DOUBLE REFRIGERATION AIR + LIQUIDE
- Ø 10 mm

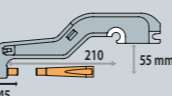
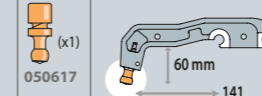
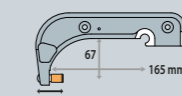
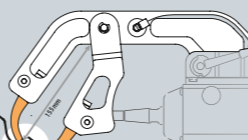
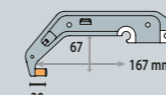
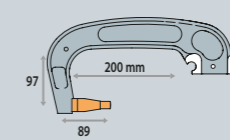
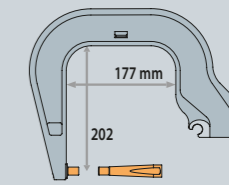
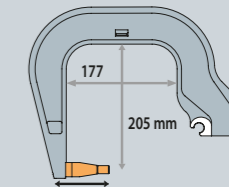
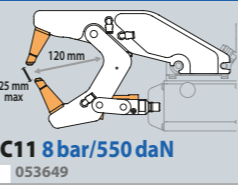
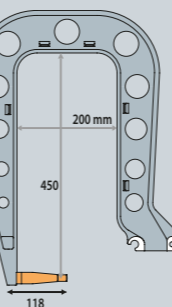
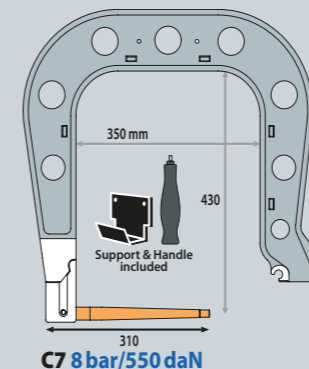
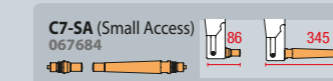
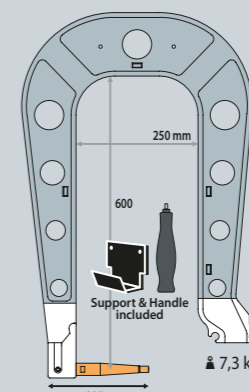
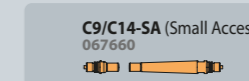
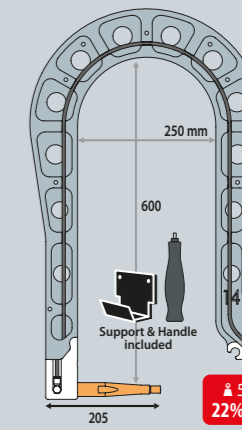
**C Arms - Caps Ø13 mm****Classic arms****CLASSIC FINISH****Bras isolés - Isolated arms - Isolierte Bügel****ELECTRICAL INSULATION****C2 8 bar/550 daN**
022386
019133**C6 8 bar/300 daN**
022409
019775**C12 8 bar/550 daN**
022997**C10 4 bar/150 daN**
051638**C5 8 bar/550 daN**
022393
019294**C1 8 bar/550 daN**
021402**C8 8 bar/550 daN**
021440
020016**C3 8 bar/550 daN**
021419**X Arms - Caps Ø13 mm****C11 8 bar/550 daN**
053649**C4 8 bar/550 daN**
021426
019164**C7 8 bar/550 daN**
021433
020009**Option for C7****C7-SA (Small Access)**
067684**C9 8 bar/550 daN**
020078**Option for C9 & C14****C9/C14-SA (Small Access)**
067660**C14 8 bar/400 daN**
023543**▲ 5,7 kg**
22% saved

SPOT WELDING

GENIUS

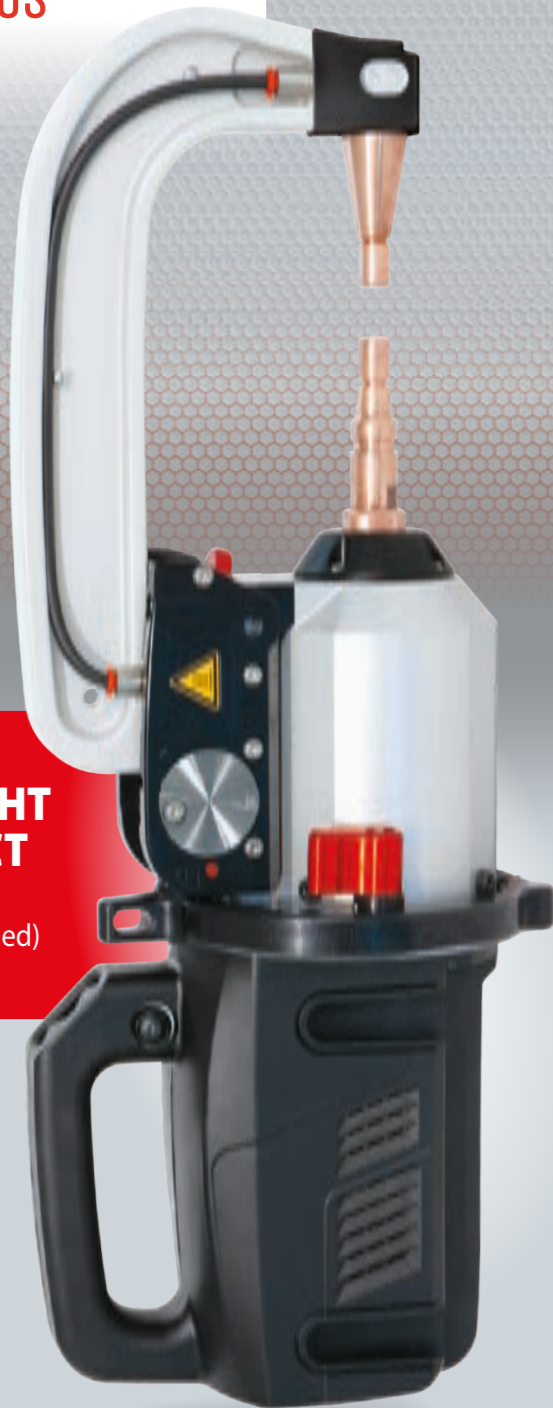

MADE IN FRANCE

ULTRA LIGHT & COMPACT
6.5 kg
(Gyro & G1 included)

550 daN
LIQUID COOLED
REFROIDISSEMENT
LIQUIDE
Ø 10 mm

6.5 kg
(Gyro & G1 included)



FAST OPEN XL

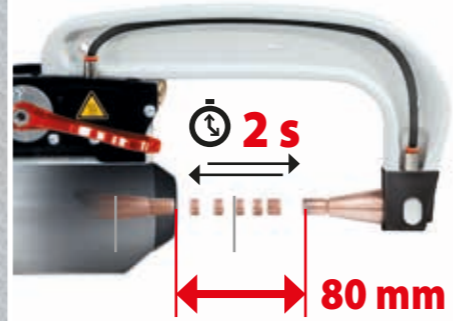

EASY



GYRO INTEGRATED



PERFECT ELECTRICAL CONNECTION



AUTO



GYSPOT INVERTER BP-LG

13 000 A
550 daN

For mild steel, HSS, UHSS | Boron steel

BP BODYPROTECT
Unique electro-magnetic field protection
by GYS

Traceability software
Save spot welding configuration
and export data

023451

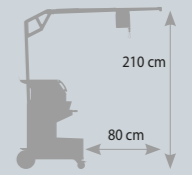
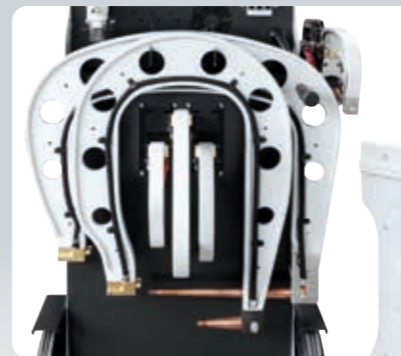

Gun & cable support

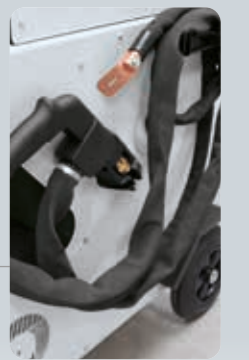

	023550	023451	023499
Gyspot BP-LG	220V	400V	
Monopoint/Spot 049291	▪	▪	▪
Spotter box pro (p.10) 050075	▪	▪	▪
Inertia hammer 049482 + 049802	▪	▪	▪
Caps remover 050846	▪	▪	▪
Arm support	▪	▪	▪
G1 022768	▪	▪	▪
G2 + G3 + G4 022898	▪	▪	▪
Liquid cooling (10l) 052246			▪ (x3)

OPTIONS

x40 (x6: 049987) 048935	SD CARD 050914	NEW Kit WIFI 070691	Liquide de refroidissement Cooling liquid Kühlmittel Enfriamiento líquido Refrigeração líquida 052246	Housse de protection - Protection cover - Schutzhaube for BP & PTI 050853	10-14 kg 059696
-------------------------	----------------	----------------------------	---	---	-----------------

MADE IN FRANCE	50/60 Hz	D curve	Spots/min (max) 2.5+2.5	RMS A	Uo V	mm				Cables		100% CU	cm	kg
						2.5+2.5+2.5	1.5+3	2.5m, Ø200mm ² , Liquid	2.5m, Ø150mm ² , air	8m 4x16mm ² (6AWG) 500W	OK			
GYSPOT B.P.LG 220 V	3x 200, 220, 240	60 (21-25 kVA), 80 (28-33 kVA), 100 (35-41 kVA)	2, 6, 10	10 500, 11 000, 12 000, 12 500	15, 17, 18	2.5+2.5+2.5	1.5+3	2.5m, Ø200mm ² , Liquid	2.5m, Ø150mm ² , air	8m 4x16mm ² (6AWG) 500W	OK	65 x 80 x 205	160	
GYSPOT B.P.LG 400V	3x 400V	32 (22 kVA), 40 (28 kVA), 50 (35 kVA)	2, 6, 10	13 000	16	2.5+2.5+2.5	1.5+3	2.5m, Ø200mm ² , Liquid	2.5m, Ø150mm ² , air	8m 4x6mm ² H07RNF	OK	65 x 80 x 205	160	

FAST OPEN XL

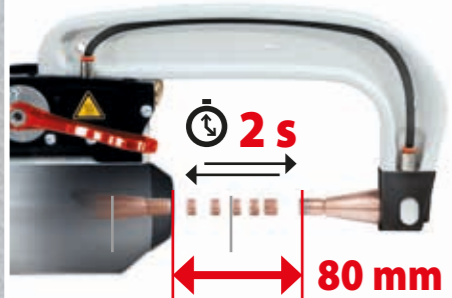

GYRO INTEGRATED

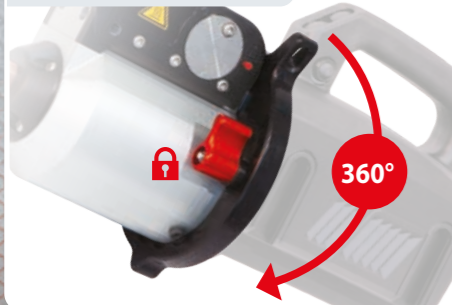

PERFECT ELECTRICAL CONNECTION

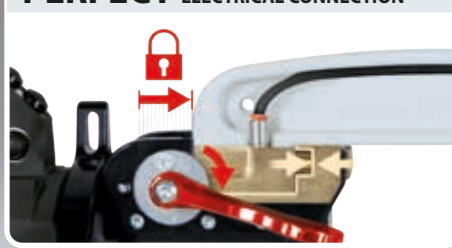

AUTO



NEW



MADE IN FRANCE

TRANSFORMER INSIDE

550 daN
LIQUID COOLED
REFROIDISSEMENT LIQUIDE
Ø 10 mm
11.3 kg
(Gyro & G1 included)



Potence électrique - Motorised cable support - Elektrisch verstellbarer Kabelsupport



Ergonomic

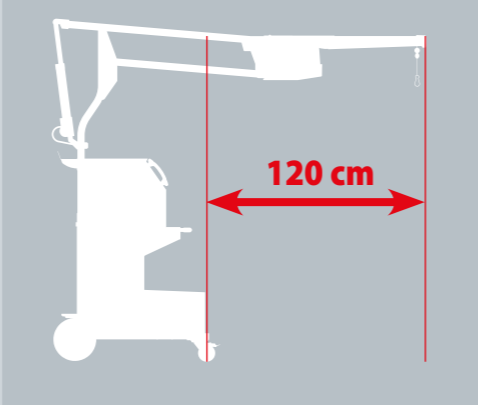

OPTIONS

		NEW Kit WIFI 070691	Liquide de refroidissement - Cooling liquid - Kühlmittel - Enfriamiento líquido - Refrigeração líquida 052246	Housse de protection - Protection cover - Schutzhaube for BP & PTI 050853
--	--	----------------------------	---	---

GYSPOT INVERTER PTI-G
14 500 A
550 daN
For mild steel, HSS, UHSS | Boron steel
TRANSFORMER INSIDE
Traceability software
Save spot welding configuration and export data

	024854	024878	068001	024892
Gyspot PTI-G	220V	400V		480V
Caps remover 050846	■	■	■	■
Arm support	■	■	■	■
G1 022768	■	■	■	■
G2 + G3 + G4 022898			■	
Kit gun 067226			■	
Liquid cooling (10) 052246			(x3)	

Included Cable support
ULTRA RESISTANT



ELECTRIC MOTOR

NEW

Grande stabilité - High stability

OPTIONS
Kit gun PTI-G 067226
300 mm² 1.8 m | 300 mm² 1m

MADE IN FRANCE	50/60 Hz	-AM- A D curve	Spots/min (max) 2.5+2.5	RMS A	Uo V	mm			Cables		cm	kg
						↕	↔	↔	↔	↔		
GYSPOT PTI.G 220 V	3 x	200 208 220 240	50 (17-21 kVA)	20	12 500 13 000 14 500 14 500	6.6 6.9 7.3 7.9	2.5+2.5+2.5	1,5+3	6 m, Liquid	8 m 4xAWG8 (500W)	71 x 90 x 200	100
GYSPOT PTI.G 400V	3 x	400V	25 (17 kVA)	20	14 500	7	2.5+2.5+2.5	1,5+3	6 m, Liquid	8 m 4x4 mm ² H07RN-F	71 x 90 x 200	100
GYSPOT PTI.G 480V	3 x	480V	20 (17 kVA)	20	14 500	7	2.5+2.5+2.5	1,5+3	6 m, Liquid	8 m 4xAWG12 (500W)	71 x 90 x 200	100

FOR GYSPOT BP-LG & PTI-G

G Arms - Caps Ø13 mm

Bras isolés - Isolated arms - Isolierte Bügel

NEW **Reversible**
for G1, G3, G4, G5, G8 & G10

Kit de maintenance connecteurs pince G - Connectors maintenance kit for G clamp 067295

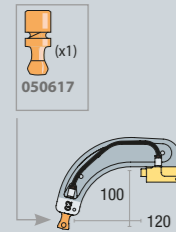

G2
8 bar/300 daN
022775

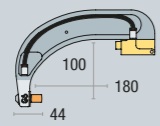

G6
8 bar/550 daN
022812

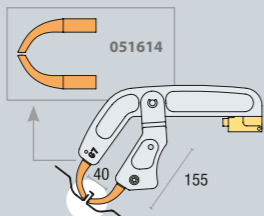

G7
4 bar/150 daN
022829

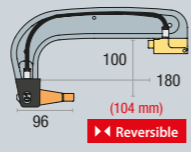

G1
8 bar/550 daN
022768

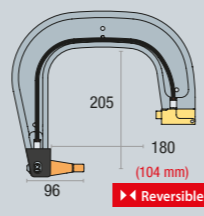

G3
8 bar/550 daN
022782

Option for G1 & G3

G1/G3-SA (Small Access)
067653 (for arms > 02/2021)

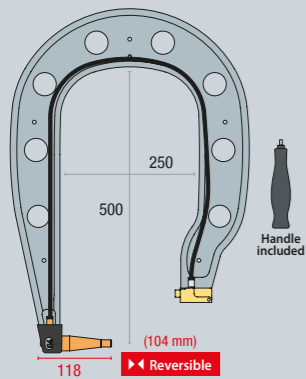

G4
8 bar/550 daN
022799

Option for G4

G4-SA (Small Access)
064478 (for arms < 01/2021)

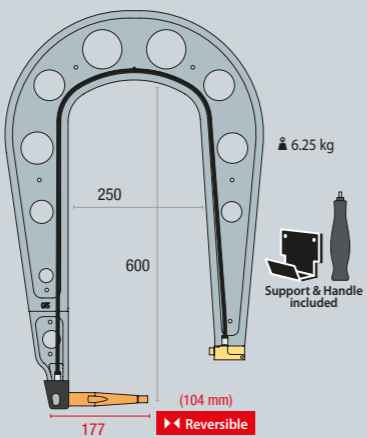

G5
8 bar/550 daN
022805

Option for G5

G5/G10-SA (Small Access)
067660

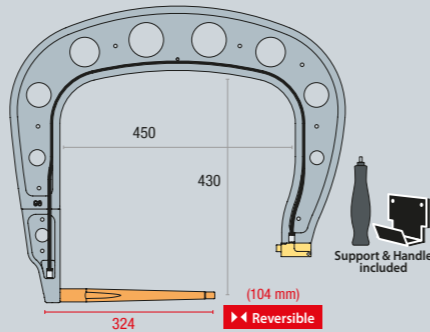

G8
8 bar/550 daN
022836

Option for G8

G8-SA (Small Access)
067677



G10
8 bar/400 daN
067165

Option for G10

G5/G10-SA (Small Access)
067660

G ARMS PANELS

G2 + G3 + G4
022898

G2 + G3 + G5
063297

G > X
UNIQUE SYSTEM by GYS

AUTOMATIC WELDING FOR X1, X2 & X6

X1 (Included with G9) 050501
550 daN

G9 8 bar/550 daN 022881

X2 050518
300 daN

X6 050587
300 daN

Protections for G clamp & arms 067288

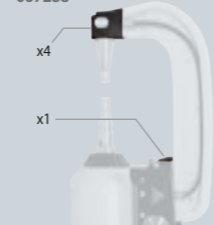

Option SD card 050914
Option PCB 97449C
90284 + 55121

CONSOUMMABLES X & C - X & C Consumables

Type A Cor X clamp Ø 13 mm (x6) 049987	Type D Cor X clamp Ø 13 mm (x10) 058507	TYPE G Ø 13 mm (x10) 059672	048935	050068
Type B Cor X clamp Ø 13 mm / Ø 5 mm (x6) 055506	TYPE F For single sided gun Ø 13 mm (x6) 049970	Caps inclinés - Beveled X2, X4, C11 arms Ø 13 mm (x6) 049994		
Graisse contact Contact grease 050440	Caps remover 050846	Europax anti-corrosion 052758		
			x40 (x6: 049987)	x10 (x20: 052239) x6 (x6: 049994)
				x18 (x6: 049987) x18 (x6: 049970)
Monopoint / Spot 049291				

AFFUTEUR DE CAPS PNEUMATIQUE - Pneumatic cap grinder

061484

Lame - Blade 061491

Type A caps

AFFUTEUR DE CAPS - Cap grinder

Lame - Blade 052857

048966

Optimal speed: 400-800 rpm

Youtube

BANC DE TRACTION ARRACHE TÔLE - Steel sheet traction bench - Blech-Zugbank zur Festigkeitsprüfung

052420

052321 (included)

VALISE TEST SOUDURE HLE / THLE - Weld test kit - Schweißtestkit im Hartschalenkoffer

050433

Barre d'arrache / Traction bar + Acier doux / Mild steel 0.65 (x25) + 1.0 (x25) + Acier HSLA 360 - HLE 0.8 (x25) + 1.5 (x25) + Acier DP600 - THLE/UHLE 1.0 (x25) + Acier FB560 - THLE/UHLE 2.5 (x25)

PROTECTION ANTI-ARC 12 V - Anti-arc protection 12V - Lichtbogenschutz 12V - Protección anti-arco 12V

041318

GYRO 360°

for BPLC/BPLCX 051737

10-14 kg

for EVOLUTION 051720

ÉCHANTILLONS DE TÔLES - Sheets set

Acier standard / Standard steel 0.8 (x65) + 1 (x55) + 1.5 (x35) + 2 (x25) + Alu 1 (x45) + 1.5 (x30) + 2 (x20) 055841

CAPTEUR D'EFFORT - Electrode force sensor

052314

KIT DE PURGE RÉSERVOIR - Tank draining kit - Kit zur Tankentleerung

058286

for GYSPOT BP & PTI

CARTE MÉMOIRE SD - SD memory card

SD CARD 050914

KIT WIFI

for 100R, BP & PTI 070691

HOUSSE DE PROTECTION - Protection cover - Schutzhaube

for BP & PTI 050853

LIQUIDE DE REFROIDISSEMENT - Cooling liquid - Kühlmittel - Enfriamento líquido - Refrigeração líquida

052246



RIVETING

PNEUMATIC HYDRAULIC



OPTIONS

Support Riveteuse pour changements d'accessoires (bras & matrice)
- Riveting machine support for changing accessories (arms & dies)
- Supportständer
↳ 28 x 40 x 21,5 cm
054158

Chariot-Trolley
↳ 79 x 81 x 51 cm
↳ 80 x 15 x 123 cm
44 kg
054233

Chariot + Support
Trolley + Support
↳ 51 x 122 x 74 cm
055391

Capteur d'effort 062115

Hydraulic body wrenches (x2) 067325

Serre-tôles - Temporary-fasteners manual mounting

(x10) Ø 2,4 mm 069664

(x10) Ø 4,0 mm 069671

(x10) Ø 4,8 mm 069688

(x10) Ø 6,4 mm 069695

NEW



UNIQUE
100%
No air inclusion
maintenance free, no oil refill

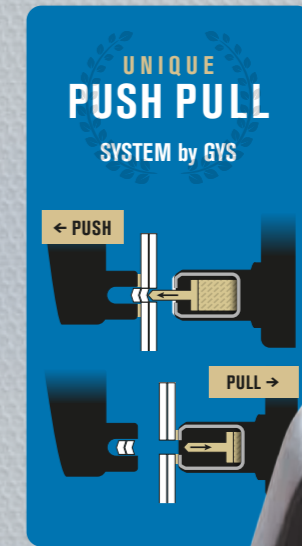

BRAS DE RIVETAGE - RIVETING ARMS - STANZIETBÜGEL

HR110 063310	HR210 063327	HR310 8T 065963	HR310 8T PP/10T/10T PP 063334
GYSPRESS 8T	✓	✓	—
GYSPRESS 10T	✓	✓	✓
GYSPRESS 8T PUSH PULL	✓	✓	✓
GYSPRESS 10T PUSH PULL	✓	✓	✓
GYSPRESS 10T CONNECT	✓	✓	✓



KIT HR210 + HR310 8T
065970
KIT HR210 + HR310 8T PP/10T/10T PP
064089

XT31-40
Rallonges bras HR310 pour point milieu - HR310 arm extension for middle point
Compatible 8T PP/10T/10T PP x2
066335

GYPRESS COMPLETE PACKS

GYSPRESS 10T 063303	HR110 063310	XT11.21 - Extension for HR110 & HR210 058644	Standard 10T tool box 053694	6 x 50 rivets RAP - Nieten SPR 048706	HR210 + HR310 064089	50kN adapter 064867	Pulling adapter kit 066076	Trolley+support 055391
GYSPRESS 10T pack 1 066441		✓						
GYSPRESS 10T pack 2 066458					✓			
GYSPRESS 10T pack 3 064744					✓			✓
GYSPRESS 10T PUSH PULL 063853	✓							
GYSPRESS 10T PP pack 1 066465					✓			
GYSPRESS 10T PP pack 2 066472					✓			
GYSPRESS 10T PP pack 3 065789					✓			✓



GYPRESS 10T
6.5 bar 100 kN
10t
063303
070653 NEW



GYPRESS 10T PUSH PULL
6.5 bar 100 kN
10t
063853
070660 NEW

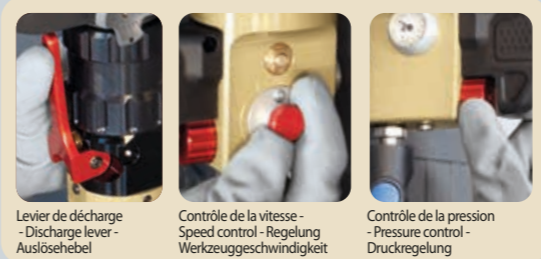

Levier de décharge - Discharge lever - Auslösehebel
Contrôle de la vitesse - Speed control - Regelung Werkzeuggeschwindigkeit
Contrôle de la pression - Pressure control - Druckregelung



Contrôle de la vitesse - Speed control - Regelung Werkzeuggeschwindigkeit
Contrôle de la pression - Pressure control - Druckregelung
Sélection Push/Pull - Push/Pull selection

	MADE IN FRANCE	AIR BAR	PRESSURE CONTROL	SPEED CONTROL	↕	⚖	↕	⚖
					cm	kg	cm	kg
GYSPRESS 10T		6.5 bar = 10 t (maxi 10 bar)	0 > 6.5 bar	+ -	39.5 x 180	6.2 (HR110 included)	58 x 48 x 15	11.8
GYSPRESS 10T PUSH PULL		6.5 bar = 10 t (maxi 10 bar)	0 > 6.5 bar	+ -	39.5 x 180	6.7 (HR110 included)	58 x 48 x 15	12.5



GYPRESS

SYNERGIC RIVETING WORKSTATION

PNEUMATIC HYDRAULIC



UNIQUE 100%
No air inclusion
maintenance free, no oil refill

ACCESSIBILITY

10 languages

- FR ES CN
- GB CZ JP
- DE NL
- IT RU

★★★★
SYNERGIC RIVETS SETTINGS

Main panel

Setup instructions



Results



3 MODES

- MANUAL
- SYNERGIC
- CAR MANUFACTURERS

CAR MANUFACTURERS COMPATIBILITY

- ✓ VW GROUP
- ✓ MERCEDES-BENZ
- ✓ BMW
- ✓ TESLA
- ✓ FERRARI
- ✓ FORD
- ✓ JAGUAR / LAND ROVER
- ✓ GM

CONNECTIVITY

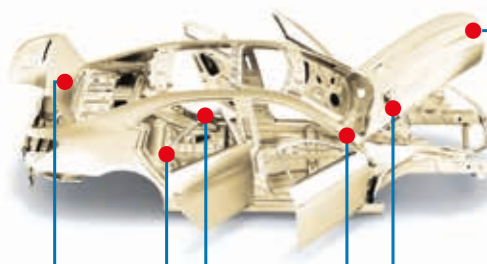

TRACEABILITY

History data export

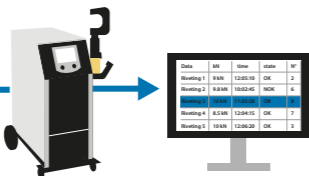

SOFTWARE UPDATE

Gyspress evolutions

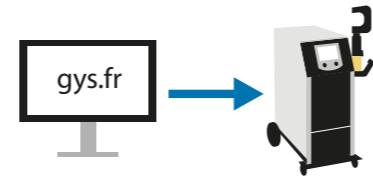

UNIQUE PUSH PULL SYSTEM by GYS

PUSH PULL SYSTEM by GYS

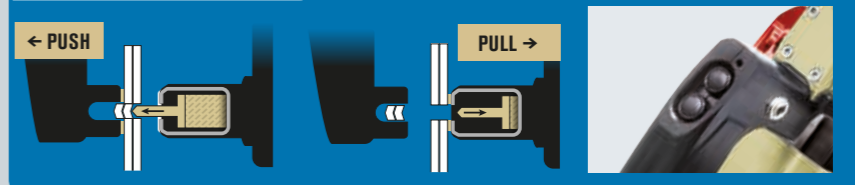

Sélection Push/Pull - Push/Pull selection

Gyspress support



Arms support



NEW 08 2021

REGULATED PRESSURE CONTROL

POWER 10t

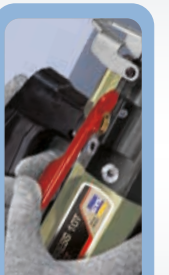

Levier de décharge - Discharge lever - Auslösehebel



WORKSTATION GYPRESS 10T PP CONTROL

6.5 bar 100 kN

10t

063860

Included

- HR110 063310
- XT11.21 - Extension for HR110 & HR210 058644
- Standard 10T PushPull tool box 058361
- 6 x 50 rivets RAP - Nieten SPR 048706
- Strap-Sangle-Gurt
- HR arm locker
- Poignée-Handle-Griff

OPTIONS

Capteur d'effort for GYPRESS 10T, 8T & 10T PushPull, 10T PP CONTROL 062115



Youtube

Hydraulic body wrenches for GYPRESS 10T, 10T PushPull, 10T PP CONTROL (x2) 067325

MADE IN FRANCE WORKSTATION GYPRESS 10T PP CONTROL	230 V	AIR BAR 6.5 bar = 10 t (maxi 10 bar)	PRESSURE CONTROL 0 > 6.5 bar	SPEED CONTROL + -	cm	kg
					N/A	N/A (HR110 included)





ADAPTATEURS POUR RIVETS AVEUGLES - BLIND RIVET ADAPTERS



GYPRESS

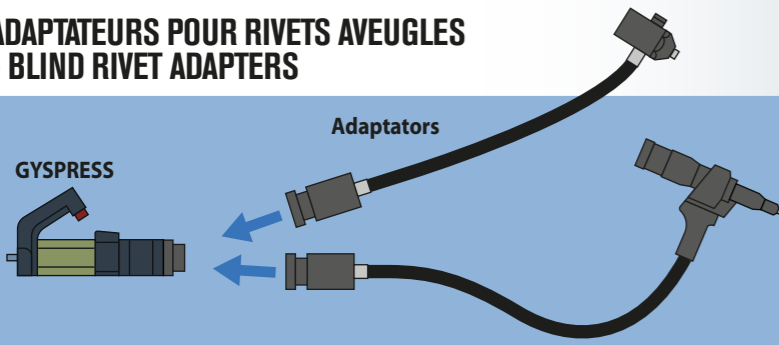

Compatibility	24 kN	50 kN
GYPRESS 8T	✓ (20 kN)	✓ (40 kN)
GYPRESS 10T	✓ (24 kN)	✓ (50 kN)
GYPRESS 8T PUSH PULL	✓ (20 kN)	✓ (40 kN)
GYPRESS 10T PUSH PULL	✓ (24 kN)	✓ (50 kN)
GYPRESS 10T CONNECT	✓ (24 kN)	✓ (50 kN)

ADAPTATEUR 24 KN POUR RIVETS AVEUGLES - Blind rivet adapter 24 kN - Blindnietadapter 24 kN

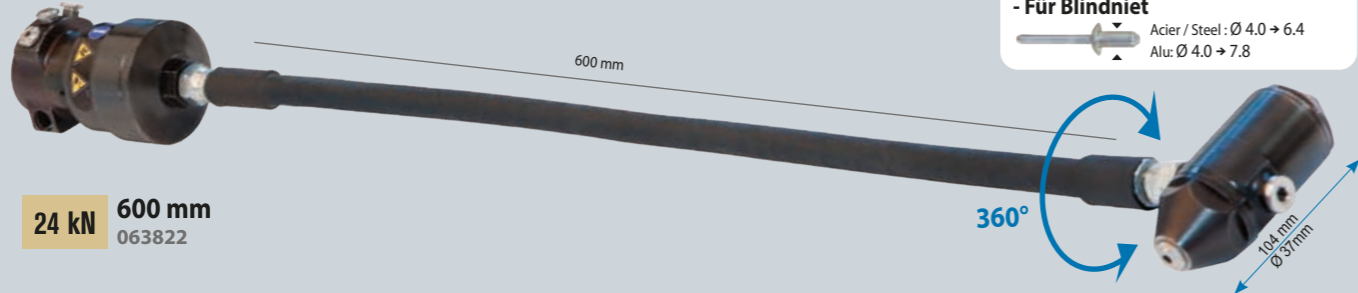

24 kN 600 mm
063822

Pour rivets POP - For BLIND rivets - Für Blindniet

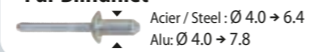

HIGH ACCESSIBILITY



SPECIFIC STORAGE



INCLUDED

for standard rivets:

Ø 3.2 x1	059221	
Ø 3.6 x1	059238	
Ø 4.0 x1	059245	
Ø 4.5 x1	059252	

PERFECT COMBO WITH ARC PULL

SPÉCIAL ARRACHAGE DE RIVETS
Special tearing rivets - Spezial-Zugnieten

1 Stainless steel rod welding with GYSPOT Arc Pull 350/700



2 Extraction of self piercing rivet with GYPRESS adapters

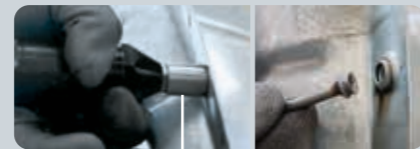

OPTION ADAPTERS

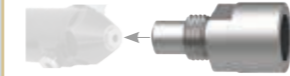

for 24 KN ADAPTER
Buse pour extraction de rivets RAP Ø4
- Extraction nozzle for Ø4 SPR rivets
064683

for 50 KN ADAPTER
Buse pour extraction de rivets Ø 4 & 5
- Extraction nose-piece Ø 4 & 5
066151

OPTION FOR GYSPOT ARC PULL (details p.15)



for GYSPOT ARCPULL 350

ARC PULL RIVET BOX 350
064584

Tige inox - Stainless steel nail Ø 4 x 50 mm	Canon pour pose de tige inox - Barrel for stainless steel nail welding	Support porte-goujon - Mandrel support	Buse + patin - Nozzle + pad	mandrel Ø4mm
x100	x1	x1	x1	x1

for GYSPOT ARCPULL 700

ARC PULL RIVET BOX 700
068452

Canon long + mandrin M5 - Long barrel + mandrel M5	Support porte-goujon - Mandrel support	Buse + patin - Nozzle + pad	Ring holder	Masse - Earth
x100	x1	x1	x2	x1

ADAPTATEUR 50 KN POUR RIVETS AVEUGLES - Blind rivet adapter 50 kN - Blindnietadapter 50 kN



50 kN 1 m
064867
▲ 4.0 kg

Réglage de la course de traction - Stroke adjustment
0 → 25 mm

Pour rivets POP - For BLIND rivets - Für Blindniet

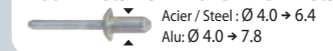

INCLUDED

Kit Standard



+ Complete kit 065987



OPTIONS

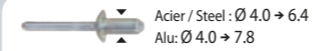

Extension 160 mm - 160 mm extension - Verlängerung 160 mm
066144



Kit Rivets Ø8.0/9.8mm - Ø8.0/9.8mm noze-piece kit - Mundstückkit 8,0/9,8 mm
066045

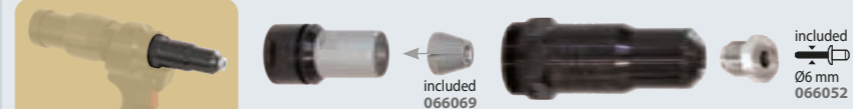

Kit 6 tirants pour pose d'écrous à sertir - Blind rivet nut pulling adapter kit - Blindnietmuttern-Kit
066076



	M5	066083
	M6	066090
	M8	066106
	M10	066113
	M12	066120
	M14	066137

BOÎTE CONSOMMABLES POUR ADAPTATEUR 50KN - Consumables box for 50kN adapter - Zubehörbox für 50 kN Adapter

066168



Écrous à sertir - Blind rivet nuts

	M5		M6		M8		M10		M12		M14
Ø mm	0.5 → 3.0	0.5 → 3.0	0.5 → 3.0	1.0 → 3.5	1.0 → 4.0	4.5 → 6.0					
	x 50 066175	x 50 066182	x 50 066199	x 50 066205	x 50 066212	x 10 066229					

+ plaque de démonstration - demo metal sheet

x 10 x 10 x 10 x 10 x 10 x 5

Goujons à sertir - Blind rivet bolts

	M5		M6		M8
mm	22.5 → 27	24 → 28.5	23.5 → 28		
mm	0.5 → 3.0	0.5 → 3.0	0.5 → 3.0		
	X 50 066236	X 50 066243	X 50 066250		

+ x 10 x 10 x 10

Rivets aveugles - Blind rivets

	Ø 6.4		Ø 9.8
mm	2.8 → 4.8	3.0 → 14.0	
	x 50 066267	x 50 066274	

+ x 10 x 10

<p>Pose de rivets auto-perçants - Application of self-piercing rivets - Stanzniet-Verpressen</p> <p>2,0 < 6,5 mm 3 < 5,8 bar</p>	<p>Pose de rivets pleins - Application of solid rivets - Vollniet-Verpressen</p> <p>2,3 < 8,3 mm 5,3 < 8 bar</p>	<p>Pose de rivets Flow-Form - Application of Flow-Form rivets - Setzen v. Fließformnieten</p> <p>2,3 < 8,3 mm</p>	<p>Extraction de rivets - Extraction of rivets - Niet-Auspressen</p> <p>2,3 < 8,3 mm 8 bar</p>	<p>Perçage et formage des tôles pour rivets pleins - Metal sheet punching and shaping - Vollniet-Lochstanzen/Prägen</p> <p>2,3 < 8,3 mm 8 bar</p>
--	--	--	---	--

BOÎTES MATRICES - Dies boxes - Matrizensätze

STANDARD



STANDARD 8T/10T for 8T 10T 053694

x1 A1	x1 A2	x1 B1	x1 B2	x1 F1	x1 F2	x1 D17	x1 E1	x1 E2	x1 T1	x1 T2	x2	x4
Self-piercing rivets				Flow-form rivets		Extraction		Punching			clé	joins
Ø 3,2, 3,5				Ø 3,3 Ø 5,3		Ø 6 - A1/2/3 S0/1/2/3/4/5/6		Ø 6				x1

Included XT11-21 058644



STANDARD 8T/10T PUSH PULL for 8T PP 10T PP 10T CONTROL 058361

x1 A1	x1 A2	x1 B1	x1 B2	x1 F1	x1 F2	x1 D17	x1 E1	x1 E2	x1 ST1	x1 T5	x1 T7	x2	x4
Self-piercing rivets				Flow-form rivets		Extraction		Punching			clé	joins	
Ø 3,2, 3,5				Ø 3,3 Ø 5,3		Ø 6 - A1/2/3 S0/1/2/3/4/5/6		Ø 6				x1	

Included XT31-60 - 60 mm extension for HR310 (use with ST1, T5, T7) 057135 + XT11-21 058644

Ø 6.4 mm Low pressure

KIT RMB PP05 for 10T PP 10T CONTROL

Ideal aluminium, aciers doux - Ideal for aluminum, mild steel 066403

x1 T3, x1 T12, x1 T13

Punching Ø 6.7

BREVET GYS GYS PATENT

Ø 6.4 mm HIGH pressure

KIT RMB 08 PREMIUM for 10T 10T PP 10T CONTROL

Ideal aciers durs, Boron - Ideal for UHSS, Boron 066403

x1 T14, x1 T15, x1 T16

Punching Ø 6.7

Flow-Form Ø 6 mm

KIT RMB 14 PREMIUM for 10T 10T PP 10T CONTROL

Ideal aciers durs, Boron - Ideal for UHSS, Boron 071186

x1 T17, x1 T18, x1 T19

Punching Ø 6

NEW

Flow-Form Ø 8 mm

KIT RMB 15 PREMIUM for 10T 10T PP 10T CONTROL

Ideal aciers durs, Boron - Ideal for UHSS, Boron 071193

x1 T20, x1 T21, x1 T22

Punching Ø 8

NEW

Ne pas utiliser avec une Gyspress 8T & 8T PP - Do not use with Gyspress 8T & 8T PP

GM



RMB 11 for 10T 071087 RMB PP04 for 10T PP 10T CONTROL 071063

x1 F1	x1 F2	x1 F6	x1 E9	x1 E11	x1 T1	x1 T2	x1 ST1	x1 T5	x1 T7	x1 T17	x1 T18	x1 T19	x1 D18	x1 D17	x2	x4
Flow-form rivets			Extraction		Punching							clé	joins			
Ø 6			Ø 6,8		Ø 6											

Included XT31-60 - 60 mm extension for HR310

FERRARI



RMB 06 for 8T 10T 8T PP 10T PP 10T CONTROL 059009

x1 B4	x1 B5	x1 B6	x1 S3	x1 S7	x1 S8	x1 D17	x1 E1	x1 E2	x1 E13	x2	x4
Self-piercing rivets				Extraction		Punching				clé	joins
Ø 3,9		Ø 4,75		Ø 3,9		Ø 4,75		Ø 3,3, 4,8 Ø 3,9, 5,3 Ø 4,75			

VW GROUP



RMB 03 for 8T 10T 8T PP 10T PP 10T CONTROL 054257

x1 A1	x1 B1	x1 S3	x1 S7	x1 S8	x1 D8	x1 D17	x1 D1	x1 D2	x1 D3	x1 D4	x1 D13	x1 E2	x1 S1	x1 S4	x1 S5	x1 D5	x1 D6	x1 D7	x1 D10	x1 D11	x1 D12	x1 D15	x1 D16	x2	x4				
Self-piercing rivets				Solid rivets		Extraction		Punching													clé	joins							
Ø 3,2, 3,5				Ø 5,3 Ø 3,9		Ø 4,75		Ø 4		Ø 6		Ø 3,2		Ø 5,3		Ø 3,9, 5,3		Ø 3,2		Ø 5,3		Ø 8		Ø 4,8		Ø 4,8 Ø 4 Ø 8 Ø 6			

MERCEDES-BENZ

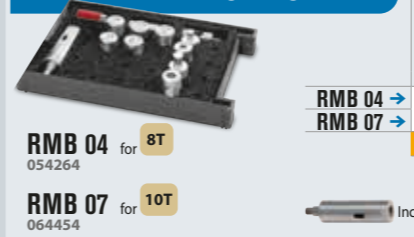

x1 F1	x1 F2	x1 F3	x1 F4	x1 F5	x1 E3	x1 E4	x1 E5	x1 E9	x1 E10	x1 E11	x1 T1	x1 T2	x1 T3	x1 T4	x2
Flow-form rivets					Extraction			Punching				clé	key		
Ø 6 - A1/2/3 S0/1/2/3/4/5/6					S28/38/48/58/68			S08/18 Ø 5,3, 8 Ø 6 Ø 8 Ø 6, 8 Ø 8 Ø 6				Ø 6		Ø 8	

RMB 04 for 8T 054264 RMB 07 for 10T 064454

Included XT31-60 - 60 mm extension for HR3 (use with E3, E4, E5, E9, E10, E11) 057135



x1 F1	x1 F2	x1 F3	x1 F4	x1 F5	x1 E9	x1 E10	x1 E11	x1 ST1	x1 ST2	x1 T5	x1 T7	x1 T8	x1 T10	x2	
Flow-form rivets					Extraction			Punching				clé	key		
Ø 6 - A1/2/3, S0/1/2/3/4/5/6					S28/38/48/58/68			S08/18 Ø 6, 8 Ø 6 Ø 6				Ø 8		Ø 8	

RMB PP01 for 8T PP 10T PP 10T CONTROL 058378

FORD

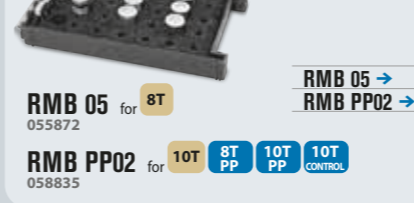

x1 B1	x1 G1	x1 G2	x1 G3	x1 G4	x1 G5	x1 G6	x1 E7	x1 E8	x1 E12	x2	x4
Self-piercing rivets							Extraction			clé	key
Ø 5, 5,3							Ø 5, 5,3				

RMB 05 for 8T 055872 RMB PP02 for 10T 8T PP 10T PP 10T CONTROL 058835

Included XT31-60 - 60 mm extension for HR3 (use with E7, E8, E12) 057135

JAGUAR / LAND ROVER

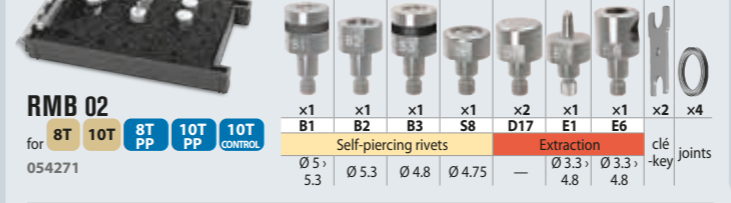

x1 B1	x1 B2	x1 B3	x1 S8	x1 D17	x1 E1	x1 E6	x2	x4
Self-piercing rivets			Extraction		Punching		clé	key
Ø 5, 5,3 Ø 5,3 Ø 4,8 Ø 4,75			Ø 3,3, Ø 3,3		Ø 3,3, Ø 4,8			

RMB 02 for 8T 10T 8T PP 10T PP 10T CONTROL 054271

BMW

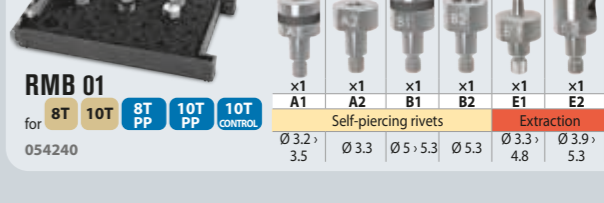

x1 A1	x1 A2	x1 B1	x1 B2	x1 E1	x1 E2	x2	x4
Self-piercing rivets				Extraction		clé	key
Ø 3,2, 3,5		Ø 3,3 Ø 5,3		Ø 5,3		Ø 3,3, Ø 3,9, 5,3	

RMB 01 for 8T 10T 8T PP 10T PP 10T CONTROL 054240



NEW

x1 B1	x1 B3	x1 I1	x1 I2	x1 I3	x1 F2	x1 F6	x1 E3	x1 E6	x1 T1	x1 T2	x1 ST1	x1 T5	x1 T7	x1 T17	x1 T18	x1 T19	x1 D18	x1 D17	x2	x4
Self-piercing rivets				Flow-form rivets		Extraction		Punching							clé	key				
Ø 5, 5,3				Ø 6		Ø 3,3, 4,8		Ø 6												

RMB 12 for 10T 071094 RMB PP07 for 10T PP 10T CONTROL 071070

Included XT31-60 - 60 mm extension for HR310

PORSCHE



NEW

x1 B3	x1 F2	x1 E9	x1 E11	x1 T1	x1 T2	x1 T5	x1 ST1	x1 T7	x1 T17	x1 T18	x1 T19	x1 D17	x2	x4
Flow-form rivets		Extraction		Punching							clé	key		
Ø 6		Ø 6, 8		Ø 6										

RMB 10 for 10T 069299 RMB PP06 for 10T PP 10T CONTROL 069305

TESLA



NEW

x1 B1	x1 H1	x1 H2	x1 H3	x1 H4	x1 H5	x1 H6	x1 H7	x1 H8	x2	x4
Self-piercing rivets									clé	key
Ø 5, 5,3			Ø 5,3							

RMB 09 for 8T 10T 8T PP 10T PP 10T CONTROL 059931



NEW

x1 B1	x1 S7	x1 S8	x1 F3	x1 F4	x1 F5	x1 D17	x1 E2	x1 E3	x1 E9	x1 E10	x1 ST2	x1 T8	x1 T10	x1 T3	x1 T4	x2	x4
Self-piercing rivets		Flow-form rivets			Extraction		Punching		clé	key							
Ø 5, 5,3		Ø 4,75			S28/38/48/58/68		S08/18		Ø 3,9, 5,3 Ø 5,3, 8 Ø 6, 8 Ø 8		Ø 8		Ø 8				

RMB 13 for 10T 071100 RMB PP03 for 8T PP 10T PP 10T CONTROL 059092

Included XT31-60 - 60 mm extension for HR3 (use with E2, E3, E9, E10) 057135



MATRICES - Dies - Matrizen

<p>Pose de rivets auto-perçants - Application of self-piercing rivets - Stanzniet-Verpressen</p> <p>2.0 < 6.5 mm 3 < 5.8 bar</p>	<p>Pose de rivets pleins - Application of solid rivets - Vollniet-Verpressen</p> <p>2.3 < 8.3 mm 5.3 < 8 bar</p>	<p>Pose de rivets Flow-Form - Application of Flow-form rivets - Setzen v. Fließformnieten</p> <p>2.3 < 8.3 mm</p>	<p>Extraction de rivets - Extraction of rivets - Niet-Auspressen</p> <p>2.3 < 8.3 mm 8 bar</p>	<p>Perçage et formage des tôles pour rivets pleins - Metal sheet punching and shaping - Vollniet-Lochstanzen/Prägen</p> <p>2.3 < 8.3 mm 8 bar</p>
---	---	--	--	---

x1	x1	x1	x1	x1	x1	x1	x1	x1	x1	x1	x1	x1	x1	x1	x1	x1	x1	x1	x1	x1	
A1	A2	B1	B2	B3	B4	B5	B6	D1	D2	D3	D4	D5	D6	D7	D8	D9	D10	D11	D12	D13	
055698	055704	055711	055728	055735	059016	059023	059030	055971	055988	055995	055742	056008	056015	056022	056039	056046	055674	056060	056053	055759	
A1+A2		B1+B2																			
054295		054301																			

x1	x1	x1	x1	x1	x5	x1	x1	x1	x1	x1	x1	x1	x1	x1	x1	x1	x1	x1	x1	x1			
D15	D16	D17	D18	E1	E2	E3	E4	E5	E6	E7	E8	E9	E10	E11	E12	E13	F1	F2	F3	F4			
056077	056084	055681	071155	055865	054288	055766	057005	057012	057029	057142	057159	057166	058606	058613	058620	058828	059085	055773	055780	055797	055803		
				E1+E2																F1+F2			
				054318																054714			

x1	x1	x1	x1	x1	x1	x1	x1	x1	x1	x1	x1	x1	x1	x1	x1	x1	x1	x1
F5	F6	G1	G2	G3	G4	G5	G6	H1	H2	H3	H4	H5	H6	H7	H8	I1	I2	I3
055810	071148	057173	057180	057197	057203	057210	057227	068230	068247	068254	068261	068278	068285	068292	068308	071117	071124	071131

x1	x1	x1	x1	x1	x1	x1	x1	x1	x1	x5	x1	x1	x1	x1	x1	x1	x1	x1	
S1	S3	S4	S5	S7	S8	ST1	ST2	ST3	T1	T2	T3	T4	T5	T7	T8	T10	T12	T13	
057036	057043	057050	057067	057074	057081	058071	058088	066397	057098	059078	057104	055827	055834	058019	058033	058040	058064	066373	066380
										T1+T2									
										054707									



x1	x1	x5	x1	x1	x1	x5	x1	x1			
T14	T15	T16	T17	T18	T19	T20	T21	T22			
066410	066427	068964	066434	069312	069329	071254	069336	070936	070943	071261	070950

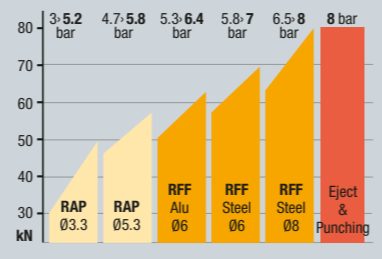

RIVETS AUTOPERÇANTS (RAP) - Self piercing rivets (SPR) - Stanznieten

Steel - Acier - Stahl

Complete box 048706							
x200	x200	x100	x100	x100	x100	x100	x100
048232	048249	048256	048263	048270	048225	048638	048645

POINTEAU CENTREUR - Special center punch - Spezialekörner

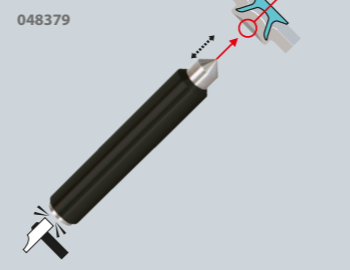

RIVETEUSE HYDRO-PNEUMATIQUE - Hydro-pneumatic tool for blind rivets - Hydro-pneum. Blindnietgerät

HR9

Pour rivets POP - For BLIND rivets - Für Blindniet

Acier / Steel Ø 3.2/4.0/4.8
Alu Ø 3.2/4.0/4.8

max 9 000 N

057234

Made in Taiwan

RIVETEUSE HYDRO-PNEUMATIQUE - Hydro-pneumatic tool for blind rivets - Hydro-pneum. Blindnietgerät

HR14

Pour rivets POP - For BLIND rivets - Für Blindniet

Acier / Steel Ø 4.0/4.8/6.4
Alu Ø 4.0/4.8/6.4

max 14 000 N

057241

Made in Taiwan

RIVETEUSE SUR BATTERIE - Cordless riveter - Akku-Blindnietgerät

TWO ER20 064461

Pour rivets POP - For BLIND rivets - Für Blindniet

Ø 4.0/4.8/5.0/6.0/6.4

max 20 000 N (6 bar)
10-20 V universal fast charger (30 min)
2.0 kg

2x 20V/2Ah Li-ion battery

RIVETEUSE MANUELLE - Manual tool for blind rivets - Manueller Blindnietgerät

Pour rivets POP - For BLIND rivets - Für Blindniet

Acier / Steel Ø 3.2/4.0/4.8/6./6.4
Alu Ø 3.2/4.0/4.8/6./6.4

061323

Made in Taiwan



SERTISSEUSE HYDRO-PNEUMATIQUE RIV 998 - Hydro-pneumatic tool for rivet nuts - Hydro-pneum. Blindnietmuttergerät

RIV 998

Ecrous à sertir - Sealing nuts - Blindnietmuttern

Pour la pose d'écrous à sertir M3 à M12
For sealing nuts from M3 to M12

max 19 000 N (6 bar)
livré avec accessoires pour écrous à sertir:
- included accessories for sealing nuts:

- ✓ M3
- ✓ M4
- ✓ M5
- ✓ M6
- ✓ M8
- ✓ M10
- ✓ M12

055414

MADE IN ITALY

RIVETEUSE HYDRO-PNEUMATIQUE - Hydro-pneumatic tool for blind rivets - Hydro-pneum. Blindnietgerät

HR21

Pour rivets POP - For BLIND rivets - Für Blindniet

Ø 4.0 → 7.8

max 21 000 N (6 bar)

055407

MADE IN ITALY

- included (x3) 058446
- For standard rivets Ø 4.0 51508
- For Magnarive rivets Ø 4.5 51507
- Option HR21 extension 100 mm 063105



AUTOGYS

GMAW MIG/MAG SYNERGIC



CARMIG

15 **▲** 200 A
400V • 3~

with accessories 032132

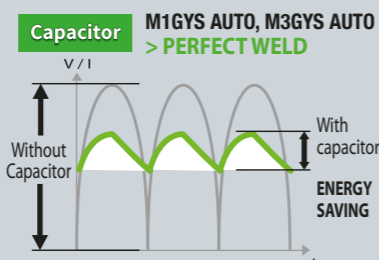

Capacitor M1GYS AUTO, M3GYS AUTO > PERFECT WELD

Without Capacitor
With capacitor
ENERGY SAVING

M1 GYS AUTO

15 **▲** 160 A Capacitor

230V • 1~
with accessories 032903

208/240V • 1~
with accessories 032088

T1 GYS AUTO

15 **▲** 200 A

400V • 3~
with accessories 032910

T1 GYS AUTO DV

15 **▲** 200 A

230V • 3~ / 400V • 3~
with accessories 032927

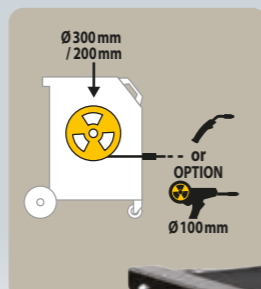

SYNERGIC - EASY TO USE
Réglage automatique de la vitesse \ Auto adaptative wire speed
Automatische Einstellung der Drahtgeschwindigkeit

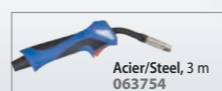
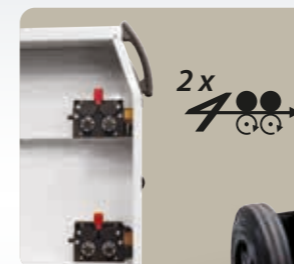
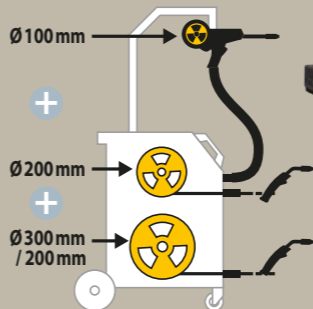

Acier/Steel, 3 m
063754

Échantillons de tôles - Sheets set

- Acier standard/ Standard steel
0,8 (x65) + 1 (x55)
+ 1,5 (x35) + 2 (x25)
- + Alu
1 (x45) + 1,5 (x30)
+ 2 (x20)
- 055841

M3 GYS AUTO

15 **▲** 160 A Capacitor

230V • 1~
with accessories: 032880

T3 GYS AUTO

15 **▲** 200 A

400V • 3~
with accessories: 032958

with accessories: 032941

T3 GYS AUTO DV

15 **▲** 200 A

230V • 3~ / 400V • 3~
with accessories: 032972

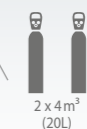

2 x 4m³
(20L)



ACCESSORIES BOX
câble secteur - mains cable
6m

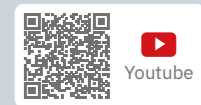

63

AUTOGYS

GMAW FCAW
CARBODY SYNERGIC MIG

OPTIONS

Torche motorisée Spool Gun - Spool Gun Torch - Spool Gun Brenner



041486

Ø 100
Ideal for
- Acier / Steel / Stahl
- Inox / Stainless steel
- Alu

included 045699

SPOOL GUN + Support for M3 & T3 GYS AUTO
038554



15L/min
(FR) 041998
(UK) 040274
(NL) 040267
(IT) 038691

OPTIMAPRO
30L/min
(FR) 043619
(UK) 043626
(DE) 043633
(NL) 043640

30L/min
(FR) 041622
(UK) 041646
(DE) 041219
(NL) 041615
(IT) 038707

041332



T3GYS & M3GYS :
Housse de protection
- Protection cover
- Schutzhaube
052260

MB 15 (150A)
041226

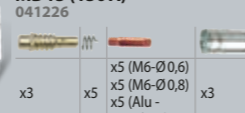

x3
x5
x5 (M6-Ø0,6)
x5 (M6-Ø0,8)
x3
x5 (Alu - M6-Ø0,8)

041806

Protection gas
Argon+CO₂ (Steel, Inox)
Argon (ALU/CuSi3/CuAl8)
CO₂PUR (Steel)

MADE IN FRANCE	MADE IN CHINA	NORM. 60974/1	50/60 Hz	A	min → max	Reg	100 (spoolgun)	200	300	Electronic Control	EN60974-1 (40°C)			Equipment d'origine Original equipment Originalausstattung Equipamiento de fabrica	cm/kg	Protected & compatible power generator (+/-15%)	
											IA (60%)	X% (I2 max)	Ø mm				
■	■	■	400V 3~	10	15 → 200	7	■	■	■	electronic	110	150A@25%	0,6+1	0,6/0,8	0,8	47x77x79 / 50	5 kVA
■	■	■	230V 1~ 208/240V 1~	16	15 → 160	6	option	■	■	400V 3~	90	140A@15%	0,6+1	0,6/0,8	0,8	47x77x79 / 46	4,5 kVA
■	■	■	400V 3~	10	15 → 200	7	option	■	■	400V 3~	110	150A@25%	0,6+1	0,6/0,8	0,8	47x77x79 / 52	5.2 kVA
■	■	■	230V 3~/400V 3~	10	15 → 200	7	option	■	■	400V 3~	110	150A@25%	0,6+1	0,6/0,8	0,8	47x77x79 / 52	5.2 kVA
■	■	■	230V 1~ 208/240V 1~	16	15 → 160	6	■	■	■	400V 3~	90	140A@15%	0,6+1	0,6/0,8 0,8/1,0	2 x 0,8	60x90x90 / 58	4,5 kVA
■	■	■	400V 3~	10	15 → 200	7	■	■	■	400V 3~	110	150A@25%	0,6+1	0,6/0,8 0,8/1,0	2 x 0,8	60x90x90 / 75	5.2 kVA
■	■	■	230V 3~/400V 3~	10	15 → 200	7	■	■	■	400V 3~	110	150A@25%	0,6+1	0,6/0,8 0,8/1,0	2 x 0,8	60x90x90 / 75	5.2 kVA

62



GMAW MIG/MAG INVERTER • SYNERGIC

4 in 1

GAS	NO GAS
MMA	TIG

1 MIG / MANUAL
Enter your parameters

Adjust Spot & Delay

2 MIG / SYNERGIC
Easy to use

Select:

- 1. material
- 2. Ø wire
- 3. position
- 4. thickness

Adjust arc length

Fe	CrNi
AlMg5	CuSi3
AISI5	AISI12
CuAl8	F.C.

3 MMA

HotStart ArcForce

4 TIG lift

Post Gas Downslope



MULTEPEARL 210-2

200 A ⚡ ⌀ 100/200

P400 PFC FV SR

GAS	NO GAS	MMA	TIG
-----	--------	-----	-----

3 m 2.5 m, 16 mm² 2 m, 16 mm²

065093

MULTEPEARL 210-4 XL

200 A ⚡ ⌀ 200/300

P400 PFC FV SR

GAS	NO GAS	MMA	TIG
-----	--------	-----	-----

3 m 2.5 m, 16 mm² 2 m, 16 mm²

065109

MULTEPEARL 211-4

200 A ⚡ ⌀ 200/300

P400 PFC FV SR

GAS	NO GAS	MMA	TIG
-----	--------	-----	-----

3 m 2.5 m, 16 mm² 2 m, 16 mm²

065116

PFC POWER FACTOR CORRECTION
185 V ↔ 265 V

FV FLEXIBLE VOLTAGE
85 V ↔ 265 V

SR SECONDARY REGULATION
I (A) STABLE

NO GAS

KIT SOUDAGE NO GAZ Ø 0.9
- No Gas Welding Kit Ø 0.9
- Schweißset Fülldraht

TYPE A
MultiPearl 200-2 only
041240

TIG torch kit SR17V (valve)
4 m
10/25 mm²
044425

TIG torch kit SR17 DB
4 m
046108

EURO

MADE IN FRANCE EN60974-1	50 / 60 Hz	I ₂			min → max	MIG		EN60974-1 (40°C)	U ₀ (V)	Ø mm			Ø mm	EQUIPEMENT D'ORIGINE	cm	kg	Protected & compatible power generator (+/-15%)		
		A	A	A		max	max			GAS	NO GAS	MMA							
MULTIPEARL 210-2	110V 1~	32	20 → 130	20 → 180	20 → 150	100	150 A @ 22%	75	15	100	200	300	0.6 + 1.0	0.9 + 1.2	1.6 + 3.2	Type A 0.8	25 x 45 x 35	16	7.5 kW
	230V 1~	13	20 → 200	20 → 200	20 → 200	130	200 A @ 20%	76	15	100	200	300	0.6 + 1.0	0.9 + 1.2	1.6 + 5.0	Type B 0.8	25 x 55 x 44	20	7.5 kW
MULTIPEARL 210-4 XL	110V 1~	32	20 → 130	20 → 180	20 → 150	100	150 A @ 22%	75	15	100	200	300	0.6 + 1.0	0.9 + 1.2	1.6 + 3.2	Type B 0.8	25 x 55 x 44	20	7.5 kW
	230V 1~	13	20 → 200	20 → 200	20 → 200	130	200 A @ 20%	76	15	100	200	300	0.6 + 1.0	0.9 + 1.2	1.6 + 5.0	Type B 0.8	41 x 73 x 77	37	7.5 kW
MULTIPEARL 211-4	110V 1~	32	20 → 130	20 → 180	20 → 150	100	150 A @ 22%	75	15	100	200	300	0.6 + 1.0	0.9 + 1.2	1.6 + 3.2	Type B 0.8	41 x 73 x 77	37	7.5 kW
	230V 1~	13	20 → 200	20 → 200	20 → 200	130	200 A @ 20%	76	15	100	200	300	0.6 + 1.0	0.9 + 1.2	1.6 + 5.0	Type B 0.8	41 x 73 x 77	37	7.5 kW



GMAW MIG/MAG INVERTER DOUBLE PULSE

Latest generation colour screen 5" 800 x 480 (WVGA)



ACCESSIBILITY

- 3 interface levels**
 - EASY
 - EXPERT
 - ADVANCED
- 10 languages**
 - French
 - English
 - German
 - Italian
 - Spanish
 - Czech
 - Dutch
 - Russian
 - Chinese
 - Japanese

1 EASY



3 INTERFACE LEVELS

2 EXPERT

Pre-gas / Hot Start / Upslope / Downslope / Crater filler / Post-gas



3 ADVANCED

Arc length adjustments



500+ JOBS can be saved



TRACEABILITY



PORTABILITY

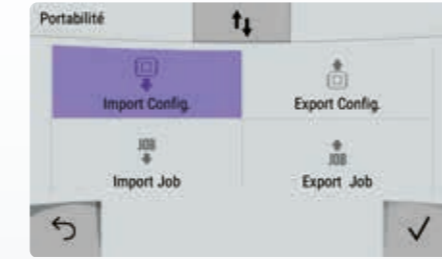

MODES

- DYNAMIC STANDARD
- PULSE
- PULSE IN PULSE
- MANUAL
- COLD PULSE**

FULLY DIGITAL

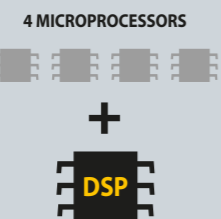

65+ SYNERGIES

Retrouvez toutes les synergies : Find all the synergies: Finde alle Synergien:



- STEEL
- Cu Si 3 / Cu Al 8
- ALU

UPDATES

EASY USB UPDATE



OPTIONS

PUSH PULL TORCH 24 V



MB 15 4m 044111
MB 25 4m 046283

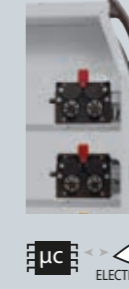

AUTOPULSE 220-M1

1	Ø 200 / 300	PP	
-	-	-	-

AUTOPULSE 220-M2

1	Ø 200 / 300	PP	
2	Ø 200 / 300		

AUTOPULSE 220-M1

15 220 A 230V 1~ PFC

with accessories:

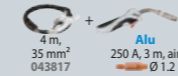

065024

AUTOPULSE 220-M1 208-240V

15 220 A 208>240V 1~ PFC

with accessories:



070868



AUTOPULSE 220-M2

15 220 A 230V 1~ PFC

with accessories:



069855

AUTOPULSE 220-M2 208-240V

15 220 A 208>240V 1~ PFC

with accessories:



069862



PFC POWER FACTOR CORRECTION

185 V ← 265 V

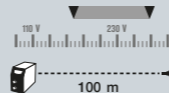

220 A • × 1

220 A • × 2

MADE IN FRANCE EN60974-1	50 / 60 Hz	A	Ø mm	min → max	SPOOLGUN	PUSH/PULL	Ø mm	Cooling system	Equipment d'origine Original equipment Originalausstattung Equipamiento de fabrica	EN60974-1 (40°C)	IA (60%)	X% (12 max)	cm / kg	Protected & compatible power generator (+/-15%)
AUTOPULSE 220-M1	230 V · 1 ~	8 m	16	0.6 + 1.2	15 + 220	-	OPTION	Air	ALU : Type B 1.0 / 1.2	150	220 A @ 20%	88x93x63 / 69	10 kVA	
AUTOPULSE 220-M1 208-240V	208 > 240 V · 1 ~	8 m	16	0.6 + 1.2	15 + 220	-	OPTION	Air	ALU : Type B 1.0 / 1.2	150	220 A @ 20%	88x93x63 / 69	10 kVA	
AUTOPULSE 220-M2	230 V · 1 ~	8 m	16	0.6 + 1.2	15 + 220	-	OPTION	Air	ACIER : Type B 0.8 / 1.0 mm ALU : Type B 1.0 / 1.2	150	220 A @ 20%	88x93x63 / 69	10 kVA	
AUTOPULSE 220-M2 208-240V	208 > 240 V · 1 ~	8 m	16	0.6 + 1.2	15 + 220	-	OPTION	Air	ACIER : Type B 0.8 / 1.0 mm ALU : Type B 1.0 / 1.2	150	220 A @ 20%	88x93x63 / 69	10 kVA	



GMAW MIG/MAG

INVERTER DOUBLE PULSE

BODYSHOP SPECIFIC
COLD PULSE
CuSi3 Ø 0.8/1



Helmet not included

2 x 4 m³ (20L)

3 x

8 m

PFC POWER FACTOR CORRECTION

185 V ← 265 V



AUTOPULSE 220-M3			
1			PP
2		-	-
3		-	-

AUTOPULSE 220-M3

15 **220 A** 230V 1~ PFC

with accessories:
4 m, 35 mm² 043817 + CuSi 150 A, 3 m, air Ø 1.0 + Steel 150 A, 3 m, air Ø 0.8 + Alu 250 A, 3 m, air Ø 1.2

036703

AUTOPULSE 220-M3 208-240V

15 **220 A** 208>240V 1~ PFC

with accessories:
4 m, 35 mm² 043817 + CuSi 150 A, 3 m, air Ø 1.0 + Steel 150 A, 3 m, air Ø 0.8 + Alu 250 A, 3 m, air Ø 1.2

062481

OPTIONS

PUSH PULL TORCH 24 V



MB 15 4 m 044111
MB 25 4 m 046283

Débimètre de bout de torche 053939

Housse de protection - Protection cover - Schutzhaube 052260

- x5 (Mg-Ø 0.6)
- x5 (Mg-Ø 0.8)
- x5 (Mg-Ø 1.0)
- x5 (Alu - Mg-Ø 0.8)
- x5 (Mg-Ø 1.0)
- x5 (Alu - Mg-Ø 1.0)
- x5 (Alu - Mg-Ø 1.2)

AUTOPULSE 320-T1				AUTOPULSE 320-T3				AUTOPULSE 320-T3 208-240V			
1			PP	1			PP	1			PP
2	-	-	-	2			-	2			-
3	-	-	-	3		-	-	3		-	-

AUTOPULSE 320-T1

15 **320 A** 400V 3~

with accessories:
4 m, 35 mm² 043817 + Alu 250 A, 3 m, air Ø 1.2

069831

AUTOPULSE 320-T1 208-240V

15 **320 A** 208>240V 3~ PFC

with accessories:
4 m, 35 mm² 043817 + Alu 250 A, 3 m, air Ø 1.2

069848

COMING SOON



10 m³ (50L)
1 x

5 m

5 m

NEW

3 x

OPTIONS

for AUTOPULSE 320-T3 (400 V) only

SPOOLGUN TORCH

Ideal Alu
Ø 0,8

4 m 041486

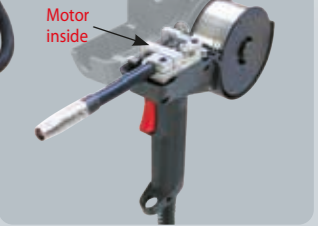

220 A • x 3

320 A • x 1

320 A • x 3

MADE IN FRANCE EN60974-1	50 / 60 Hz	A	Ø mm	min → max	SPOOLGUN	PUSH/PULL	200	Cooling system	Equipement d'origine Original equipment Originalausstattung Equipamiento de fabrica		EN60974-1 (40°C)	cm / kg	Protected & compatible power generator (+/-15%)
									ELECTRONIC CONTROL	IA (60%) X% (I2 max)			
AUTOPULSE 220-M3	230 V · 1~	8 m	16	0.6 → 1.2	15 → 220	-	OPTION	Air		ACIER : Type B 0.8 / 1.0 mm ALU : Type B 1.0 / 1.2	150 220 A @ 20%	88x93x63 / 69	10 kVA
AUTOPULSE 220-M3 208-240V	208 > 240 V · 1~	8 m	16	0.6 → 1.2	15 → 220	-	OPTION	Air		ACIER : Type B 0.8 / 1.0 mm ALU : Type B 1.0 / 1.2	150 220 A @ 20%	88x93x63 / 69	10 kVA

MADE IN FRANCE EN60974-1	50 / 60 Hz	A	Ø mm	min → max	SPOOLGUN	PUSH/PULL	200 300	Cooling system	Equipement d'origine Original equipment Originalausstattung Equipamiento de fabrica		EN60974-1 (40°C)	cm / kg	Protected & compatible power generator (+/-15%)
									ELECTRONIC CONTROL	IA (60%) X% (I2 max)			
AUTOPULSE 320-T1	400 V · 3~	5 m	16	0.6 → 1.2	15 → 320	-	OPTION	Air		ALU : Type B 1.0 / 1.2	260 320 A @ 35%	90x92,5x63 / 82.5	16 kVA
AUTOPULSE 320-T1 208-240V	208 > 240 V · 3~	5 m	25	0.6 → 1.2	15 → 320	-	OPTION	Air		ALU : Type B 1.0 / 1.2	260 320 A @ 35%	90x92,5x63 / 82.5	16 kVA
AUTOPULSE 320-T3	400 V · 3~	5 m	16	0.6 → 1.2	15 → 320	OPTION	OPTION	Air		ACIER : Type C 0.8 / 1.0 mm ALU : Type C 1.0 / 1.2	260 320 A @ 35%	90x92,5x63 / 82.5	16 kVA
AUTOPULSE 320-T3 208-240V	208 > 240 V · 3~	5 m	25	0.6 → 1.2	15 → 320	-	OPTION	Air		ACIER : Type C 0.8 / 1.0 mm ALU : Type C 1.0 / 1.2	260 320 A @ 35%	90x92,5x63 / 82.5	16 kVA



AUTOPULSE 320-T3 Old design 036710

AUTOPULSE 320-T3

15 **320 A** 400V 3~

with accessories:
4 m, 35 mm² 043817 + Steel 250 A, 3 m, air Ø 1.0 + Steel 250 A, 3 m, air Ø 0.8 + Alu 250 A, 3 m, air Ø 1.2

067615

AUTOPULSE 320-T3 208-240V

15 **320 A** 208>240V 3~ PFC

with accessories:
4 m, 35 mm² 043817 + Steel 250 A, 3 m, air Ø 1.0 + Steel 250 A, 3 m, air Ø 0.8 + Alu 250 A, 3 m, air Ø 1.2

036970

HELMETS

TECHNOLOGY

	Intensity (A)														
	1.5	70	100	125	150	175	200	225	250	300	350	400	450	500	600
MAG	8	9	10			11			12			13			
MIG			9	10		11			12		13	14			
MIG light alloys				10	11	12			13		13				
PLASMA			9	10	11	13									

Teinte initiale - Initial shade



Classic

ULTRA CLEAR

Spectre de couleur - Spectrum view

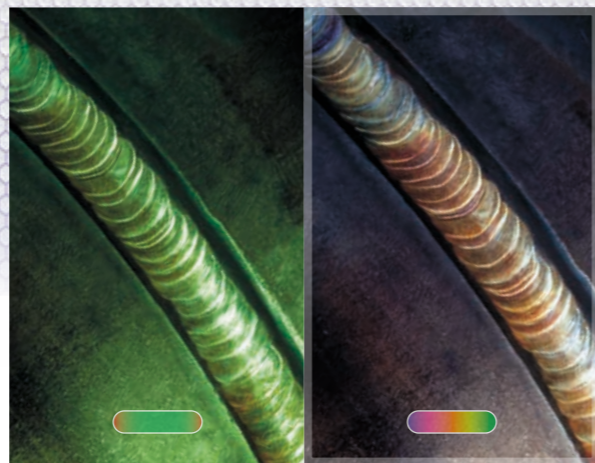

Classic

TRUECOLOR

Capteurs sensibles - Sensitivity sensors

Classic

HIGH SENSIBILITY



Sensors x2

Sensors x4

Sensors x7

Classification - X=/X=/X=/X=

1/1/1/1 = PERFECT QUALITY

(1) Qualité optique (distorsion). (2) Diffusion de la lumière (contraste). (3) Variation de la transmission lumineuse (homogénéités de la teinte foncée). (4) Lumière angulaire (filtre de rayons lumineux diagonaux).

(1) Optical quality (distortion). (2) Light diffusion (contrast). (3) Variation of light transmission (homogeneities of the dark shade). (4) Angular light (diagonal light ray filter).

(1) / (2) / (3) / (4)

Serre-tête - Headgear



Simple

Multi

COMFORT PRO

MULTIFIT +

Comfortable back

ERGOFIT +

Comfortable back / Perfect stability

HELMETS

9-13



LCD FIREMAN 9-13 TRUECOLOR 062269

◀ 100 x 49 mm | □▶ 0.1 ms
GRIND TRUECOLOR

IDEAL



LCD GYSMATIC 9/13 G AIR TRUECOLOR 043909

◀ 100 x 60 mm | □▶ 0.08 ms
GRIND + (10-11) x 4 TRUECOLOR

LCD GYSMATIC 9/13 G AIR TRUECOLOR 065727

Filtration class EN 12941: TH2 P R SL
Air 165 / 200 / 220 L/min
Battery included
OPTION Filter TH3 065734



HELMETS

5-9/9-13



ZEUS 5-9/9-13 G INDIAN 038332

◀ 100 x 67 mm
□▶ 0.1 ms
GRIND + (10-11) x 4 TRUECOLOR



ZEUS 5-9/9-13 G FIRE 044098



ZEUS 5-9/9-13 G COSMIC 044104

OPTIONS

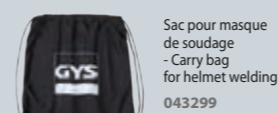

Sac pour masque de soudage - Carry bag for helmet welding 043299



066656



Bandeau anti-transpiration - Antiperspirant - headband 043466 for Multifit+, Ergofit + Multi, Simple 062627 for Comfort Pro x2 070844 for Gysmatic 9/13 Air, Gysmatic 5/13 Air XXL



Loupe - Magnifying glass for Zeus, Ergotech & Alien True Color x1 zoom x2 042780 zoom x3 064140

VERRES - Lenses - Schutzgläser	Dimensions	Part No.	Model	TRUECOLOR	HF	DELAY	Classification	Sensitivity	View	Weight	Brand		
226 x 106 (x5)	103.6 x 54 (x5)	045781	LCD FIREMAN 9-13 TRUECOLOR	■	—	0.10 ms	4-9>13	1/1/1/2	2	100x49 mm	Multifit+	490 g	Gys
114x133 (x10)	G: 106 x 66 (x10)	043893	LCD GYSMATIC 9/13 G TRUECOLOR	■	✓	0.08 ms	4-9>13	1/1/1/2	4 HIGH SENSIBILITY	XL: 100x60 mm	Simple	580 g	Gys
114 x 133 (x10)	103.7 x 69.5 (x5)	043893	ZEUS	■	—	0.10 ms	4-5>9 / 9>13	1/1/1/2	4	XL: 100x67 mm	Multi	520 g	Gys

HELMETS

5-9/9-13

ERGOTECH

100 x 67 mm

0.12 ms



TRUECOLOR



ERGOTECH 5-9/9-13 SILVER 044173



ERGOTECH 5-9/9-13 BLACK 045477



ERGOTECH 5-9/9-13 DREAM 037212

ERGOTECH + NEW 09 2021

100 x 67 mm

0.1 ms



ULTRA CLEAR 3 CLASS 1/1/1/1

TRUECOLOR



ERGOTECH + 5-9/9-13 SILVER 068650



ERGOTECH + 5-9/9-13 BLACK 068667



ERGOTECH + 5-9/9-13 DREAM 068674



Multifit +



ALIEN XXL TRUECOLOR 037229

100 x 90 mm

0.15 ms



TRUECOLOR



GYSMATIC XL TRUECOLOR 037908

100 x 60 mm

0.08 ms



TRUECOLOR



ALIEN + NEW 09 2021

100 x 90 mm

0.1 ms



ULTRA CLEAR 3 CLASS 1/1/1/1

TRUECOLOR



ALIEN XXL + TRUECOLOR 068698



Multifit +

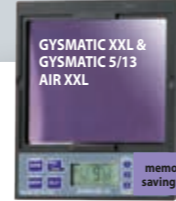

Comfort Pro



GYSMATIC XXL TRUECOLOR 037236

100 x 83 mm

0.1 ms



CLASS 1/1/1/1 DIGITAL TRUECOLOR



Battery charger 037472 028869



Battery included 037465



038424 x1

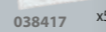

038417 x5

GYSMATIC 5/13 AIR XXL TRUECOLOR 047846 028852

Filtration class EN 12941: TH2 P R SL Air 165 / 200 220 L/min Battery included

OPTION Filter TH3 065734



PANORAMIC



APOLLO 5-9/9-13 G TRUECOLOR 037809



PANORAMIC TRUECOLOR

100 x 67 mm | 0.12 ms

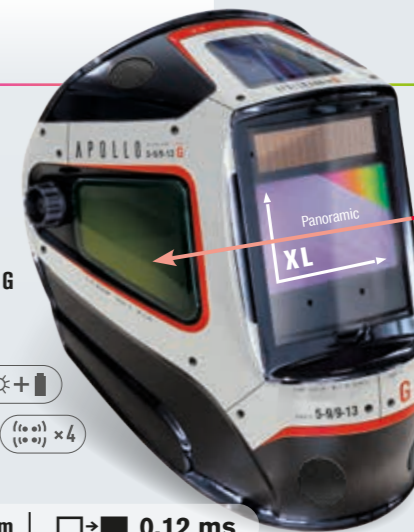

4-5-9/9-13 Adjustable

Fixed shade 5

Fixed shade 5

APOLLO + NEW 10 2021

100 x 67 mm | 0.1 ms



CLASS 1/1/1/1 ULTRA CLEAR 3 PANORAMIC TRUECOLOR



Multifit +



PANORAMIC 3XL TRUECOLOR 037281

114 x 85 mm

0.15 ms



ULTRA CLEAR 3 PANORAMIC TRUECOLOR



3-4-8/8-12 Adjustable

Shade 3-10

Shade 3-10

VERRES - Lenses - Schutzgläser				TRUECOLOR	HF	DELAY									MASK BRAND	
	114 x 133 (x10)	043893	103.7 x 69.5 (x5)	043695	ERGOTECH	4-5>9/9>13	0.12 ms	—	0.15 > 0.8 s	1/1/1/2	4 HIGH SENSITIVITY	XL: 100x67 mm	☼ + 2 (CR 2450)	Multi	560 g	Gys
					ERGOTECH +	3-5>9/9>13	0.10 ms	—	0.15 > 0.8 s	1/1/1/1	4 HIGH SENSITIVITY	XL: 100x67 mm	☼ + 2 (CR 2450)	MultiFit +	580 g	Gys
	114 x 133 (x10)	043893	104 x 96 (x5)	043596	ALIEN XXL TRUECOLOR	4-5>9/9>13	0.15 ms	—	0.15 > 0.8 s	1/1/1/2	4 HIGH SENSITIVITY	XXL: 100x90 mm	☼ + 2 (CR 2032)	Multi	560 g	Gys
					ALIEN XXL + TRUECOLOR	3-5>9/9>13	0.10 ms	✓	0.15 > 0.8 s	1/1/1/1	4 HIGH SENSITIVITY	XXL: 100x90 mm	☼ + 2 (CR 2032)	MultiFit +	560 g	Gys
	110 x 90 (x5)	040816	106 x 66 (x10)	043886	GYSMATIC XL TRUECOLOR	4-5>9/9>13	0.08 ms	✓	0.1 > 0.9 s	1/1/1/1	4 HIGH SENSITIVITY	XL: 100x60 mm	☼ + 2 (CR 2450)	Comfort	540 g	Gys
	114 x 133 (x10)	043893	106 x 89.5 (x10)	046825	GYSMATIC XXL & 5/13 AIR XXL TRUECOLOR XXL	4-5>9/9>13	0.10 ms	✓	0.1 > 0.9 s	1/1/1/1	4 HIGH SENSITIVITY	XXL: 100x83 mm	☼ + 2 (CR 2450)	Comfort Pro	680 g	Gys
	114 x 133 (x10)	043893	103.7 x 69.5 (x5)	043695	APOLLO 5-9/9-13 G	4-5>9/9>13 + 2x: 5	0.15 ms	—	0.15 > 0.8 s	1/1/1/2	4 HIGH SENSITIVITY	XL: 100x67 + 2x103.7x69.5 mm	☼ + 2 (CR 2450)	Multi	580 g	Gys
					APOLLO + 5-9/9-13 G	3-5>9/9>13 + 2x: 5	0.10 ms	—	0.15 > 0.8 s	1/1/1/1	4 HIGH SENSITIVITY	XL: 100x67 + 2x103.7x69.5 mm	☼ + 2 (CR 2450)	MultiFit +	580 g	Gys
	390 x 150 (x3)	037311	special kit (x1)	037304	PANORAMIC 3XL TRUECOLOR	3-4>8/8>12 + 2x: 3>10	0.15 ms	✓	0.15 > 0.8 s	1/1/1/1	4 HIGH SENSITIVITY	114x85 + 2x(68x80) mm	☼ + 2 (CR 2450)	Multi	610 g	Gys

HELMETS

4-8/8-13



EXCLUSIVE FOR PROFESSIONAL



GYSMATIC FLIP-FLAP GOGGLE 3 TRUECOLOR
068711

GYSMATIC GOGGLE 3 TRUECOLOR
068704

◀ 130 x 58 mm | □ → ■ 0.05 ms



NEW
11 2021

◀ 130 x 58 mm | □ → ■ 0.1 ms



NEW
11 2021

ERGOFIT +

ULTRA CLEAR INITIAL SHADE 3

DIGITAL CONTROLS AUTOMATIC & MANUAL OPTIONS

WIDE VISION XL

ERGOFIT +

ULTRA CLEAR INITIAL SHADE 3

DIGITAL CONTROLS AUTOMATIC & MANUAL OPTIONS

180° XXL

PANORAMIC VIEW & WIDE VISION XXL

x7 HIGH SENSITIVITY SENSORS

TORCHES ASPIRANTES - Fume Extraction Torches

BINZEL

Acier/Inox - Steel/Stainless steel - Stahl/Edelstahl

AIR	150 A	250 A
original equipment	M6	M6
	Ø0.8	Ø1.0
X % 40°C - ArCO ₂	150A - 60%	200A - 60%
GRIP		GRIP
L	3m	3m
Ref.	043251	040540

ASPIRATEUR DE FUMÉE - Fume Extraction System

BINZEL

- 230V / 1 ~, 1100 W
- 200 m³/h max
- 190 mbar max
- 26 kg, 390 x 210 x 500 mm
- 71 db
- Système de nettoyage automatique du filtre - Filter auto cleaning system - Automatische Filterabreinigung

Automatic ON/OFF
043237
Manual
043244

100 m³/h

ASPIRATEURS DE FUMÉE - Fume Extraction Systems - Rauchgasabsauggerät

UNI 2.0 RE

- 400V / 3 ~ / 50 Hz
- 1100 W
- 1300 m³/h max
- 3-4h/day
- arm 3 m
- no plug
- 100 kg
- extraction 0.5 m/s

061545



Included
Pré-filtre (treillis aluminium) -
Pre-filter (aluminium mesh)
Class G3 EN 779

Filtere - Filter
Class H12 EN 779
Filtration > 99 %
046467

Option
Flexible d'extraction
10 m
Ø 150 mm
062139

EVO 2.1 RE

- 230V / 1 ~ / 50 Hz - 32A
- 1100 W
- 1200 m³/h max
- occasional
- arm 3 m
- included
- 85 kg

061552



Breveté - Patented

Included
Pré-filtre (treillis aluminium) -
Pre-filter (aluminium mesh)
Class G3 EN 779

Filtere - Filter
Class H12 EN 779
Filtration > 99 %
046467

Option
Flexible d'extraction
10 m
Ø 150 mm
062139

PROFI MASTER

- 1100 W
- 1100 m³/h
- 72 dB (A)
- arm 3m
- 104 Kg (with arm)
- 400V / 3 ~ / 50 Hz

067783



Pre-filter
x1
067820

Main filter
x1
067844

SMART MASTER

- 1100 W
- 950 m³/h
- 72 dB (A)
- occasional (1 sel N)
- arm 3m
- 81 kg (with arm)

- 230V / 1 ~ / 50 Hz
- included
067769

- 115V / 1 ~ / 60 Hz
- no plug
067776



Pre-filter
x10
067790

Pre-filter
x10
067806

Main filter
x1
067813

VERRES - Lenses - Schutzgläser	TRUECOLOR	HF	DELAY	ERGOFIT	MASK BRAND								
290 x 147.5 (x10) 071025	135.2 x 62.8 (x10) 071018	LCD GYSMATIC FLIP-FLAP GOGGLE 3	3 - 4 > 8 / 8 > 13	0.05 ms	—	0.06 > 1.0 s	1/1/1/1	3	XL : 138x58 mm	—	ERGOFIT +	578 g	Gys
385.8 x 137.7 (x10) 070998	133.5 x 60.4 (x10) 070981	LCD GYSMATIC GOGGLE 3	3 - 4 > 8 / 8 > 13	0.10 ms	✓	0.06 > 0.10 s	1/1/1/1	7 HIGH SENSITIVITY	XXL : 130x58 mm + 2x52x48 mm	—	ERGOFIT +	580 g	Gys



INDUCTION HEATING

CAR BODY

PFC POWER FACTOR CORRECTION

185 V ← 265 V



Youtube



PACKS - GYSDUCTION AUTO

	PROLINER AUTO 048775	COMPLETE AUTO 053380	COMPLETE AUTO + 056978	MECA AUTO 048812	MECA AUTO + 056961	BODY SHOP AUTO 048799	GLASS AUTO 048805	DENT REPAIR AUTO 054981
1 box	=	=	=	=	=	=	=	=
GYSDUCTION AUTO	✓	✓	✓	✓	✓	✓	✓	✓
Plastic wedges 051294	✓	✓	✓	-	-	✓	✓	-
Burn off Inductor 053373	✓	✓	✓	-	-	✓	✓	-
Body Inductor 053359	✓	✓	✓	-	-	✓	-	-
Bolt Inductor 053366	✓	✓	✓	✓	✓	-	-	-
Remote control 055490	✓	✓	✓	✓	✓	✓	-	-
Universal 800 051331	✓	-	-	-	-	-	-	-
Cable support 052284	✓	-	-	-	-	-	-	-
Dent pulling Inductor 054776	-	-	-	-	-	✓	-	✓
Spiral inductor 054783	-	-	✓	-	✓	-	-	-



055490

GYSDUCTION AUTO

2 400 W 230 V • 1 ~

PFC AIR



3 m

NEW

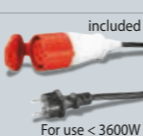

For use < 3600W

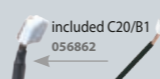

included C20/B1 056862

COMBIDUCTION AUTO 50LG

5 200 W 230 V • 1 ~

PFC LIQUID

065901



2 in 1

50LG



AUTO

INCLUDED COMBIDUCTION



Décapage Glass Entfernen 053373



Démontage Decal Entkleben 053359



OPTIONS

Inducteur spirale - Spiral inductor - Spiralinduktor 054783



1.2 kW



2.5 m

Débosselage sans peinture - PDR: Paintless Dent Repair - Lackschadenfreies Ausbeulen 054776

Licensed by BETAG innovation



3 m

Spray refroidisseur - Freezer spray

-50 °C 400 ml (x 12) 048898

Adhesive for logo (x10) 051492

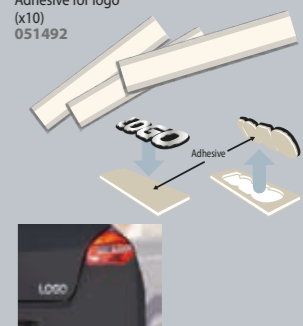

CONSUMABLES

for	for	for
Cable support 052284	Protection (x5) + Colle - Stick 053854	Protection (x10) + Colle - Stick 053847

EN 60 335/1	MADE IN FRANCE	Cable L (m)	Inductor	Heating	cm	kg	Protected & compatible power generator (+/-15%)						
								A	W	kHz	PFC	Liquid Cooling	M10 → 1 s
GYSDUCTION AUTO	230 V, 1~, 50/60 Hz	16 mini	2400	35+100	■	2	2.5	M10 → 1 s	2 mm → 5 s	Ø8 → 10 s	36 x 27 x 22	7.5	3 kW
COMBIDUCTION AUTO 50LG	230 V, 1~, 50/60 Hz	25 mini	5200	20+80	■ 71	8	3	M14 → 1 s	2 mm → 3 s 4 mm → 5 s	Ø10 → 10 s	59 x 88 x 59	72	6 kW



POWERDUCTION

INDUCTION HEATING

MAINTENANCE / MECHANIC / INDUSTRY

PFC POWER FACTOR CORRECTION

185V ↔ 265V

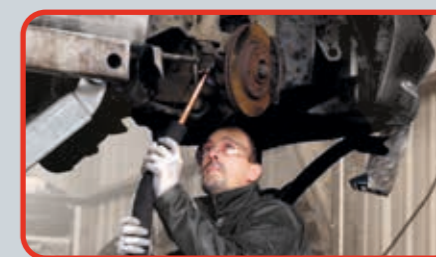
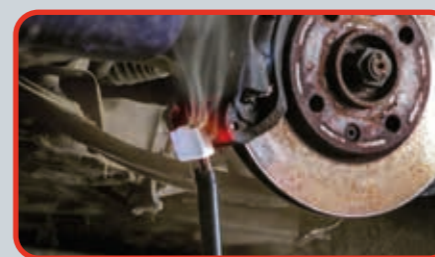

81

POWERDUCTION

INDUCTION HEATING

INCLUDED

Spirale - Coil - Spiralförmiger draht

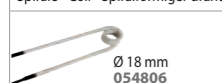

Ø 18 mm
054806



Ø 24 mm
054790



Ø 30 mm
055469

Fil tressé enroulable - Flexible
wrappable wire - Flexibel
geflochtener draht



800 mm
054813

Fil droit rigide - Straight rigid wire
- Steif gerade draht

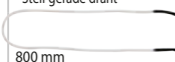

800 mm
054868



1 m

POWERDUCTION 10R

1 200 W 230V • 1~

AIR

062504

068643



2 m

POWERDUCTION 37LG

3 700 W 230V • 1~

LIQUID

065992

3 m



included C20/B1
056862

POWERDUCTION 39LG

3 700 W 230V • 1~

PFC LIQUID

058583



included
For use < 3600W

included C20/B1
056862

3 m



POWERDUCTION 50LG

5 200 W 230V • 1~

PFC LIQUID

055599

included adapter
32L + L90
064515 + 059788

4 m



POWERDUCTION 110LG

11 000 W 400V • 3~

LIQUID

058590

POWERDUCTION 110LG 208-240V

11 000 W 208-240V • 3~

LIQUID

065246

NEW

OPTION 10R

NEW

Decal - Décollage - Entkleben
066601



OPTION 37LG



Cable support
052284

Chariot - Trolley
UNIVERSAL 800
051331



Youtube

EN-60 335/1	MADE IN FRANCE	Cable L (m)	A	W	Freq. kHz	INTEGRATED TECHNOLOGY		Liquid Cooling	Cable L (m)		Heating		cm	kg	Protected & compatible power generator (+/-15%)
						P400	PFC		Inductor	Heating	Heating				
POWERDUCTION 10R	230V, 1~, 50/60 Hz	10 mini	1 200	45+80	—	—	—	2	1	M10 → 1s	2 mm → 5 s	Ø8 → 10 s	23 x 14 x 10	3	1.5 kW
POWERDUCTION 37LG	230V, 1~, 50/60 Hz	16 mini	3 700	15+30	—	—	1.51	2	2	M10 → 1s	2 mm → 5 s	Ø10 → 15 s	45 x 29 x 25	15	4 kW
POWERDUCTION 39LG	230V, 1~, 50/60 Hz	16 mini	3 700	20+60	—	—	71	2	3	M12 → 1s	2 mm → 5 s	Ø10 → 15 s	53 x 70 x 37	39.5	4 kW
POWERDUCTION 50LG	230V, 1~, 50/60 Hz	25 mini	5 200	20+60	—	—	71	8	3	M14 → 1s	2 mm → 3 s 4 mm → 5 s	Ø10 → 10 s	59 x 88 x 59	70	6 kW
POWERDUCTION 110LG 400V	400V, 3~, 50/60 Hz	16 mini	11 000	20+60	—	—	71	5	4	M18 → 1s	2 mm → 2 s 4 mm → 4 s	Ø10 → 7 s	59 x 88 x 59	80	15 kW
POWERDUCTION 110LG 208-240V	208-240V, 3~, 50/60 Hz	35 mini	11 000	20+60	—	—	71	5	4	M18 → 1s	2 mm → 2 s 4 mm → 4 s	Ø10 → 7 s	59 x 88 x 59	86	15 kW



POWERDUCTION - ACCESSORIES & CONSUMABLES



included adapter 32L + L90 064515 + 059788

included adapter 32L + L20/B4 064515 + 067882

POWERDUCTION 160LG

POWERDUCTION 160LG 208-240 V

POWERDUCTION 220LG

16 000 W 400V • 3~

16 000 W 208-240V • 3~

22 000 W 400V • 3~

* LIQUID

* LIQUID

* LIQUID

057814

065253

066861

CE NORM. EN-60 335/1	MADE IN FRANCE	Cable L (m)	Freq.		Cable L (m)	Heating		cm	kg	Protected & compatible power generator (+/-15%)				
			A	W		kHz	Liquid Cooling				Inductor	Heating		
			32 mini	16 000	20+60	301	4	6	M20 → 1s	2 mm → 2s 4 mm → 4s	Ø10 → 5s	70 x 118 x 60	120	22 kW
			45 mini	16 000	20+60	301	4	6	M20 → 1s	2 mm → 2s 4 mm → 4s	Ø10 → 5s	70 x 118 x 60	130	22 kW
			32 mini	22 000	20+60	301	4	6	M45 → 3s	8 mm → 9s 4 mm → 3s	Ø10 → 4s	70 x 118 x 60	125	22 kW

OPTIONS

NEW
Poignée de lance - Removable handle - Abnehmbarer Griff for POWERDUCTION 220 - 160 - 110 LG 068599

NEW
Housse de protection - Protection cover - Schutzhaube for POWERDUCTION 160LG 050853

NEW
Cooling liquid (not included)
5L 062511
10L 052246

t° POWER HEAT CONTROLLER

t° CONTROL
80>350°C (210>660°F) **NEW**

5,5m

POWER HEAT CONTROLLER
061644

Included T° sensors thermocouple type K x2

QR code and Youtube link

OPTIONS

Pyrometer IR for inductor L90
1.1 m 064119

INDUCTEURS - Inductors

SMALL (Ø16)

	S90	S70	S180	S20/B1 (20°)	S180/B1	S180/B2	S180/B3W	S180/D20	S180/D25	S180/D30	S180/D35	S180/D40	S180/D45	S180/D50	S180/D55
* = original equipment	058927	061569	059269	064874	064881	064928	067899	069985	069992	070592	070608	070615	070622	070639	070646
37 LG	✓*			✓			✓								
39 & 50 LG							✓ with adapter 28S								
110 & 160 LG							✓ with adapter 32S								
220 LG							✓ with adapter 32S								

LARGE (Ø32)

	L90 (90°)	L70 (70°)	L180	L180/Spiral	L20/B4	L20 Alu Glove	L180/D60	L180/D70	L180/D80	L180/D90	L180/D100	L180/D110	L180/D120
* = original equipment	059788	059771	059795	065000	067882	069114	069923	069930	069121	069947	069954	069961	069978
37 LG													
39 & 50 LG			✓ with adapter 28L							✓ with adapter 28L			
110 & 160 LG	✓* with adapter 32L*				✓ with adapter 32L							✓ with adapter 32L	
220 LG			✓ with adapter 32L		✓ with adapter 32L*							✓ with adapter 32L	

ADAPTER

	28S M28 Ø16 064485	32S M32 Ø16 064508	28L M28 Ø32 064492	32L M32 Ø32 064515
37 LG				
39 & 50 LG	✓			
110 & 160 LG			✓	
220 LG			✓	✓

COMPLETE (Ø28)

	C20/B1 (20°) 056862	C180/B1 (90°) 056879	C180/B2 (90°) 056886
39 & 50 LG	✓*		✓

BOÎTES - Boxes

28S/B for 39LG & 50LG 065802
included: S20/B1 (x1), S180/B1 (x1), S180/B2 (x1), 28S (x1), B1 (x1), B2 (x1)

32S/B for 110LG & 160LG 065819
included: S20/B1 (x1), S180/B1 (x1), S180/B2 (x1), 32S (x1), B1 (x1), B2 (x1)

L box 065796
included: L70 (x1), L180 (x1)

FERRITES - Ferrites - Ferritaufsatz

B1 053823
B2 053458
B3 067875
B4 053755

B1 056909
B2 056916
Cloche accostage 069701
B4 054844

Colle-Stick bi-composants Power Epoxy 150°C 054851



CUTTER

PLASMA

1~

COMPRESSOR COMPRESSOR INSIDE

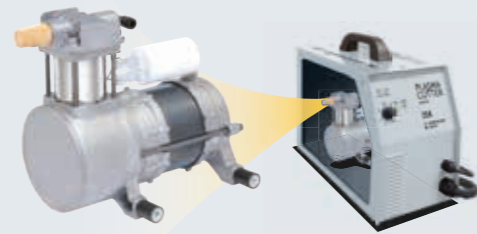

AD ANTI-DUST VENTILATION CORRIDOR

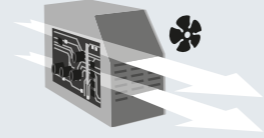

PFC POWER FACTOR CORRECTION

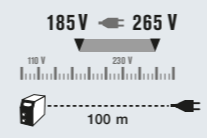

FV FLEXIBLE VOLTAGE

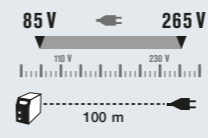

CNC COMPUTER NUMERICAL CONTROL

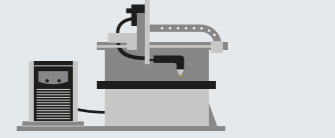

NEW 09 2021



AIR FILTER

PFC EN 61000-3-12 POWER FACTOR CORRECTION

NEW NAME

DIGITAL (PRESSURE SENSOR)



INCLUDED: 8mm

NEW 09 2021



IDEAL CARBONY REPAIR

PFC EN 61000-3-12 FV FLEXIBLE VOLTAGE

DIGITAL (PRESSURE SENSOR)



INCLUDED: 8mm



DIGITAL (PRESSURE SENSOR)

COMPRESSOR Compressor inside

EASYCUT K25

230 V • 1 ~

25 A Fe 8 mm Al/CrNi 6 mm

P400 COMPRESSOR

TPT 25, 4 m 2 m, 10 mm²

068063

EASYCUT K35F

230 V • 1 ~

35 A Fe 15 mm Al/CrNi 10 mm

P400 PFC AD COMPRESSOR

MT35K, 4 m 2 m, 10 mm²

031036

EASYCUT 25

230 V • 1 ~

25 A Fe 8 mm Al/CrNi 6 mm

TPT 25, 4 m 2 m, 10 mm²

065543

CUTTER 30FV

110 → 230 V • 1 ~

30 A Fe 15 mm Al/CrNi 10 mm

P400 PFC FV

TPT 40, 4 m 060753 2 m, 10 mm²

013858

EASYCUT 40

230 V • 1 ~

40 A Fe 18 mm Al/CrNi 15 mm

TPT 40, 4 m 060753 2 m, 10 mm²

029743

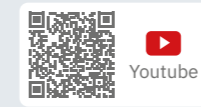

CUTTER 45 CT

110 → 230 V • 1 ~

45 A Fe 30 mm Al/CrNi 20 mm

P400 PFC FV GRID CUT AD IP 23 CNC ANALOGIC

MT 70, 6 m 2 m, 10 mm²

014787 013629 062962

OPTIONS

COMPAS for TPT 40, TPT 25, MT 25K / MT 35K

x1 040199

040205

R max = 670 mm

Consumables	MT25K	TPT25	MT35K	TPT40
	x4 040182	x4 040236	x4 040229	x4 040236
	x10 040151	x10 040212	x10 040212	x10 040212
	x2 040175	x2 040175	x2 040175	x2 040175
	x10 040168	x10 040168	x10 040168	x10 040168

Chariot - Trolley

PLASMA 600
39 x 62 x 58 cm
30 x 11 x 63 cm
8.8 kg 040298

Universal 800
48 x 81 x 62 cm
52 x 15 x 81 cm
18 kg 051331

Jobsite XL
60 x 115 x 59 cm
67 x 25 x 48 cm
039568

Filtre déshumidificateur spécial Plasma - Compressed air cleaning filter for Plasma Cutter 40 039728

Cartouche pour filtre - Filter cartridge 039735

Country	Model	Voltage	I ₂	Coupe max Severance cut			Coupe propre Clean cut			Perçage Piercing			INTEGRATED TECHNOLOGY				AIR SYSTEM			EN 60974-1 (40°C)		cm	kg	Protected & compatible power generator (+/-15%)		
				Fe	Al/CrNi	Fe	Al/CrNi	Fe	Al/CrNi	P400	PFC	FV	GRID CUT	AD	IP23	CNC	COMPRESSOR	min	ideal	max	I 60%				X% I2 max	100%
FR	EASYCUT K25 New	230V1~	16	10 → 25	8	6	6	4	—	—	—	—	—	—	—	—	—	—	included	15 A	26%	—	43 x 35 x 20	15	4.1 kW	5.9 kVA
	EASYCUT K35F	230V1~	16	10 → 35	15	10	10	8	—	—	—	—	—	—	—	—	—	—	included	28 A	30%	20 A	62 x 56 x 32	33	8 kW	10 kVA
FR	EASYCUT 25 New	230V1~	16	10 → 25	8	6	6	4	—	—	—	—	—	—	—	—	—	—	2.5 bar 115 L/min	6.5 bar 15 A	30%	10 A	15 x 42 x 30	8	—	—
	EASYCUT 40	230V1~	32	10 → 40	20	15	15	12	—	—	—	—	—	—	—	—	—	—	2.5 bar 115 L/min	6.5 bar 10 A	20%	—	15 x 42 x 30	8	—	—
FR	CUTTER 30FV	230V1~	16	10 → 30	15	10	10	8	—	—	—	—	—	—	—	—	—	—	5 bar 115 L/min	9 bar 15 A	30%	20 A	45 x 28 x 20	10.8	6.5 kW	6 kVA
		110V1~	32	10 → 30	32	10 → 30	32	10 → 30	32	10 → 30	32	10 → 30	32	10 → 30	32	10 → 30	32	10 → 30	5 bar 115 L/min	9 bar 15 A	25%	15 A	—	—	—	—
	TPT 40	230V1~	16	15 → 45	20	15	15	10	8	6	—	—	—	—	—	—	—	—	5 bar 115 L/min	7 bar 15 A	50%	32 A	—	—	—	—
	CUTTER 45CT	230V1~	32	15 → 45	30	20	25	15	12	10	—	—	—	—	—	—	—	—	5 bar 115 L/min	7 bar 15 A	50%	32 A	48 x 37 x 23	15	10.5 kW	8 kVA
	MT 70	110V1~	32	15 → 30	15	10	10	8	—	—	—	—	—	—	—	—	—	—	5.2 bar 185 L/min	7 bar 15 A	25%	17 A	—	—	—	—

CUTTER / EASYCUT PLASMA CUTTING • 1 ~



COFFRET DE DÉCOUPE PARE-BRISE - Professional Box Set for Windscreen Removal
- Frontscheiben-Trennsystem für Akkuschrauberbetrieb

MADE IN HIGH QUALITY GERMANY

057654

included
Axe enrouleur
068100

included
65 m
resistance 170 kg
Ø 0.79 mm
058125

optional
65 m
resistance 190 kg
Ø 0.92 mm
069275

NEW



COUPEAU PNEUMATIQUE DE DÉCOUPE PARE-BRISE
- Oscillating Pneumatic Saw for Windscreen Removal
- Druckluft-Trennmesser für Windschutzscheiben

057623



EXTRACTEUR D'ESSUIE-GLACE - Removal tool for windscreen wiper arms - Wischerarm-Abzieher

UNIVERSEL
057630



EXPERT

Accès difficile
- Difficult access
057647



SYSTÈME DE DÉCOUPE PARE-BRISE À CLIQUET
- Windshield Cutting kit - Set zum Lösen von Windschutzscheiben

054738

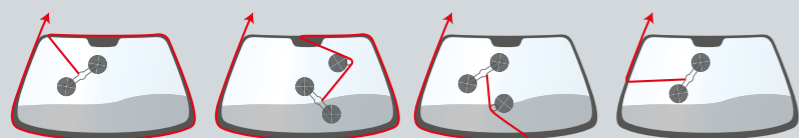

PROTECTIONS TABLEAU DE BORD
- Dashboard Protector - Armaturenbrett Schutz

053120



OUTIL DÉCOUPE PARE-BRISE
- Windshield Cutting Tool - Windschutzscheiben Demontage-Set

051935



KIT DÉCOUPE JOINT DE PARE-BRISE - Windscreen Joint-cutting Kit - Scheibentrenn-Werkzeug-Set

051898



Corde à piano torsadé (22 m)
- Windscreen seal cutting wire (twisted)
- Piano-Schneiddraht, gedreht, 22 m Rolle
051911

Corde à piano carré (50m)
- Windscreen seal cutting wire (square)
- Vierkant-Draht, 50 m Rolle
051881

VENTOUSES - Suction Lifting Pads - Saugnapfwerkzeug für Spiegelgläser

056695



051966



x6
057609



RENOV'POLYCARBONATE - Compressed air polisher - Druckluftpolierer

Complete pack

1 ponceuse orbitale
+ 1 lustreuse
- 1 orbital sander
+ 1 polisher

052086



2 SPEED

+

+

+

+

+

+

+

+

+

+

+

+

+

+

+

+

+

+

+

+

+

+

+

+

+

+

+

Ø 76

P 500 (x 10)
P 800 (x 10)
P 1500 (x 10)
P 3000 (x 10)

P 500 x 50 052017
P 800 x 50 052024
P 1500 x 50 052031
P 3000 x 50 052048

polisher Ø75
058224



AGRAFEUSE POUR RÉPARATION PARE-CHOCS - Hot stapler for bumper repair - Stoßstangen Reparatur Kit

052925



INCLUDED:
x20 x20 x20 x20 x20

MADE IN TAIWAN

PORTABLE
Sur batterie - Battery operated
058118

included
Li-ion battery 3.7V
048669
included adapters:
EUR, UK, USA & AUS

Charger included
048652

MADE IN TAIWAN



INCLUDED:
Ø 0.6, x100 Ø 0.8, x100
Ø 0.6, x100

Agrafes - staples

Angle interne étroit - Inside corner Ø 0.7 mm	Alignement de fissure - Crack alignment Ø 0.7 mm	Fissure importante - Large crack Ø 0.7 mm	Angle interne - Internal angle Ø 0.7 mm	Angle externe - External angle Ø 0.7 mm
x 100 047990	x 100 047983	x 100 047976	x 100 047969	x 100 047952
052413				
=	+	+	+	+
x 50	x 50	x 50	x 50	x 50

COFFRET DE PERÇAGE PARE-CHOCS POUR DÉTECTEURS - Piercing Kit for Bumper Sensors - Lochwerkzeug für Stoßfänger



PRO+
059139

Ø 17-18-18,2
19-20-22,5-24
26-26,7-32 mm



FREEZER

Spray refroidisseur
- Freezer spray

-50 °C
400 ml

(x 12)
048898



COFFRET DE RÉPARATION DES PLASTIQUES AUTOMOBILES - Brazing automotive plastics repair kit - Kunststoff Reparatur Set



052932

MADE IN BELGIUM



x10
052956

25 x 12.5 cm
x2
052949

057258

052963

STATION DE SOUDAGE DES PLASTIQUES - Plastic welding station - Kunststoff-Schweißset

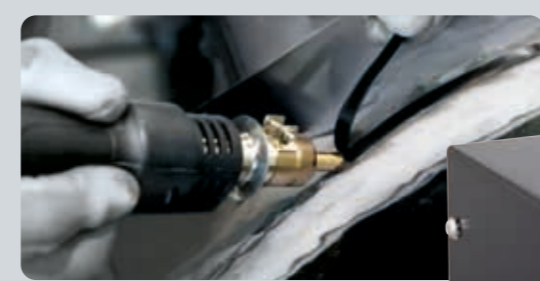

OPTION



Trolley SPOT 600
053533

320 W - 230 V, 1-50 Hz
Temperature : 160 < 480°C
▲ 3.4 kg
Length of hose : 1 m
Air flow : 24 l/min

Station seule
- Station only
064072



Ø 5 mm
066694

Ø 8 mm
066700

baguettes plastique 440 mm	PP / EPDM	▲ 4 mm	x 10	066304
		■ 6 mm	x 10	067622
	ABS	▲ 4 mm	x 10	066298
		■ 8 mm	x 10	071322
		▲ 4 mm	x 10	071322
		■ 8 mm	x 10	071339

	Station	PP/EPDM			Pressure wheels	Mini milling machine	Scraper
		▲ 4mm (x10)	■ 6mm (x10)	■ 8mm (x10)			
064072	✓						
062726			✓				
070974				✓			



Grattoir - Scraper
068032

Roulette de compression
- Pressure wheels
058231

Mini fraiseuse -
Mini milling machine
063228

Tungsten drill Ø 5 mm
included
063235

KIT DE SOUDAGE DES PLASTIQUES - Welding Kit for Plastics - Kunststoff-Schweißset



t°
20 - 700°C



1 600 W - 230V - 50/60 Hz
max. 230 l/min
▲ 1.3 kg / -L Ø100 x 300mm,
poignée Ø 56mm.

057678



Options



TIP Ø5
061262

TIP insert Ø5
061279



20mm

x10
052956

x1
25 x 12.5 cm
052949

GYS HAND TOOLS - Ausbeulwerkzeug

• **FULL PACK =**
061637

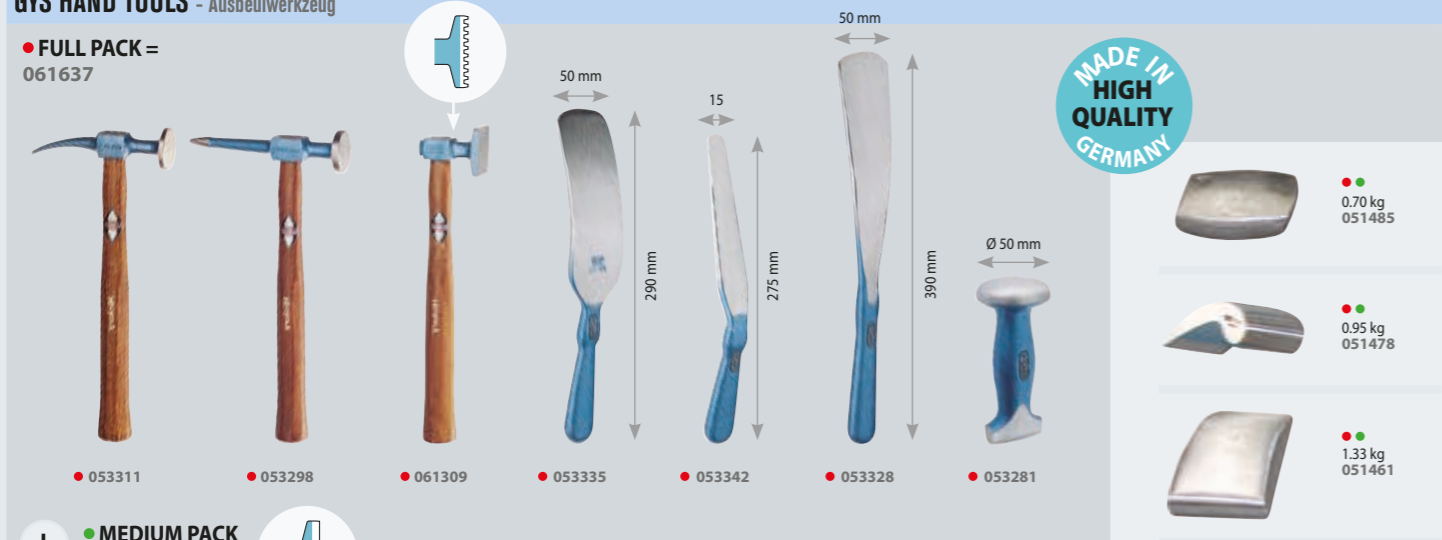

+ • **MEDIUM PACK**
051133



KIT MARTEAUX ET TAS - Planishing Kit for Car Body (Set of 3 Hammers + 4 Dollies) - Karosseriehammer & Handfaust Kit



OUTILS DE FORME - Forming tools - Formgebungswerkzeuge



OUTILS DE DÉGARNISSAGE ET RACLAGE - Set of 30 Tools for scraping/sanding and paint removal - Polster & Schaber Kit

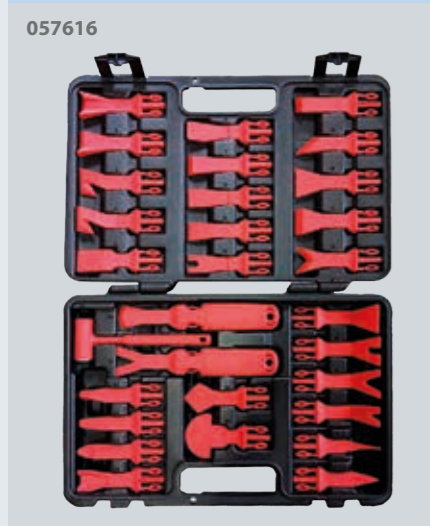

BURINS - Hand Chisel for Car Body - Meißel für Karosserie

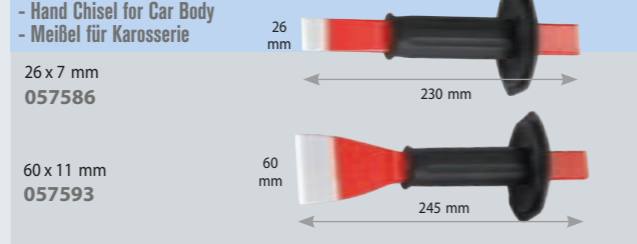

JEU DE 4 BURINS EN NYLON - Set of 4 nylon chisels - 4 Kunststoffmeißel

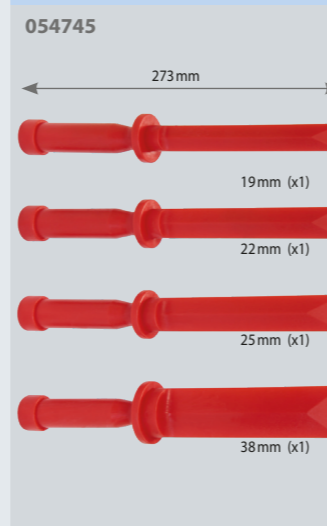

COUTEAUX RACLOIRS



JAUGES DE PROFIL - Contour Gauge - Konturenlehre



JAUGES DE POSITIONNEMENT - Gapping gauges - Spaltmaßlehre



OUTIL DE REMISE EN FORME PASSAGE DE ROUE - Fender roller tool set

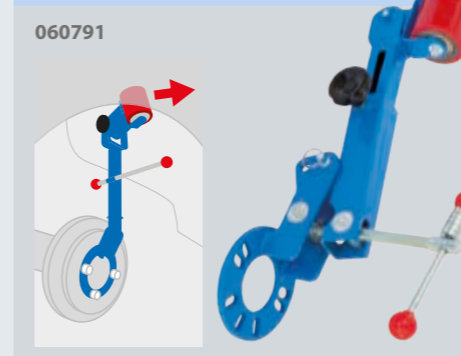

REDRESSEUR DE CHARNIÈRE DE PORTE - Fixed Hinge Bending Tool



PINÇES DE MAINTIEN BORD À BORD - Positioning clamp - I-Stoß-Lehre

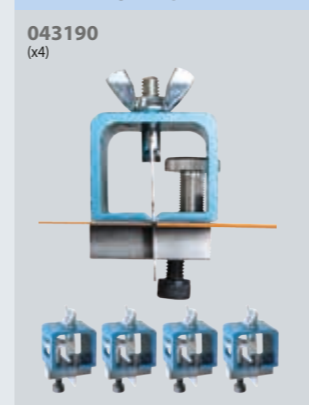

PINÇES MICRO-GRIP - Micro-grip clamps



PINÇES ÉTAU À BEC PLAT - Flat nose lock-grip pliers



SERRE-TÔLES - Temporary-fasteners manual mounting

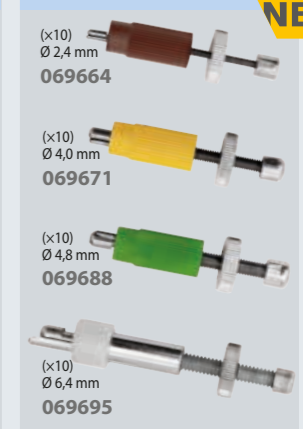

PINÇES AXIALES - Axial-grip pliers

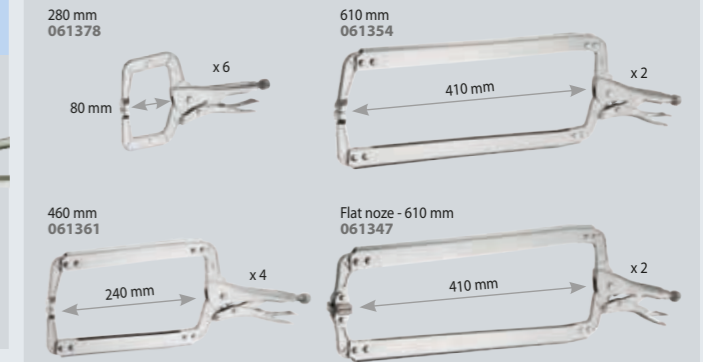
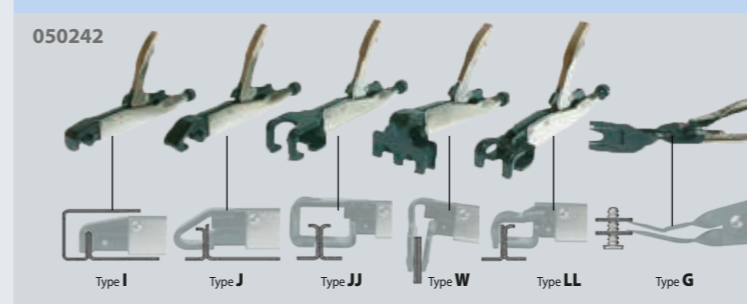

PINÇES ÉTAU MONO SERRAGE - Lock-grip pliers

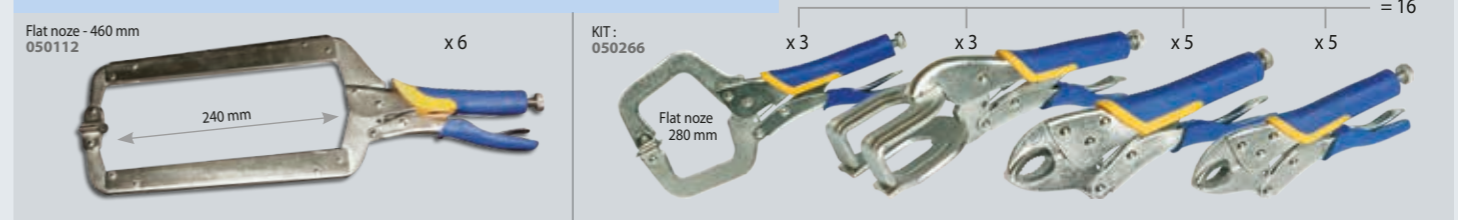

MINI-MEULEUSE - Mini disc sander - Druckluftschleifer

051829

Speed adjustment

Ø 75 mm

Speed rpm	Power W	dB	Air consumption l/min	Air pressure bar	cm	kg
18000	200	83	171	6.2	12	0.7

Included (x1) 052468

MEULEUSE D'ANGLE - Long Handled Angle Grinder - Druckluft-Winkelschleifer

057753

Ø 100 mm

± 1.6 mm, x5 057883
± 0.8 mm, x5 058217

Speed rpm	Power W	dB	Air consumption l/min	Air pressure bar	cm	kg
14000	84	113	6.2	37	1.7	

058248

MINI-FLEXIDISC LAMELLES ZIRCON Ø 50 mm

K 40 (x10) 058255
K 60 (x10) 058262
K 80 (x10) 058279

x2 Ø
Ø 50 & 75 mm

Speed rpm	Power W	dB	Air consumption l/min	Air pressure bar	cm	kg
15000	84	91	6.2	10	0.6	

MINI-MEULEUSE À RENVOI D'ANGLE - Mini Angle Grinder - Mini-Druckluftwinkelschleifer geräuschgedämpft

051867

Ø 50 mm

90°

Speed rpm	Power W	dB	Air consumption l/min	Air pressure bar	cm	kg
15000	200	86	85	6.2	18	0.75

(x1) 052772

PONCEUSE À BANDE À TÊTE ORIENTABLE - Air belt sander - Druckluft Bandschleifer

060906

520 mm

20 mm

360°

Grain 60 (x5) 060913
Grain 80 (x5) 060920
Grain 100 (x5) 060937
Grain 36 céramique (x5) 062535

Speed rpm	Power W	dB	Air consumption l/min	Air pressure bar	cm	kg
16000	171	6.3	34	1.2		

SCIE COUPE TÔLE DROITE ET LIME - Saw for Straight Cut and File - Druckluftsäge und Feile

051805

(x5) 052789

included 058750

Speed rpm	Power W	dB	Air consumption l/min	Air pressure bar	cm	kg
5000	—	85	255	6.2	10	0.8

PONCEUSE À BANDE À TÊTE ORIENTABLE - Air belt sander - Druckluft Bandschleifer

052819

360°

330 mm

10 mm

Grain 80 (x10) 052833
Grain 36 céramique (x20) 062528

Speed rpm	Power W	dB	Air consumption l/min	Air pressure bar	cm	kg
16000	171	6.3	26	0.9		

MINI-FRAISEUSE À RENVOI D'ANGLE - Mini Angle Milling Machine - Mini-Winkelschleifer

051836

90°

Speed rpm	Power W	dB	Air consumption l/min	Air pressure bar	cm	kg
18000	500	81	85	6.2	18	0.7

PERCEUSE MANDRIN AUTOMATIQUE - Automatic Mandrel Drill - Druckluftbohrmaschine m. Schnellspannfutter

051799

Ø 13

Speed rpm	Power W	dB	Air consumption l/min	Air pressure bar	cm	kg
800	300	92	170	6.2	18	0.9

COFFRET DÉCAPEUSE PNEUMATIQUE - Pneumatic surface remover Kit - Druckluftentroster-Box inkl. Zubehör

051775

Roue gomme 115 x 14 mm 051874
Roue à décaper 115 x 14 mm 051843
Adaptateur pour brosse 051768

Brosse souple Brins droits 0.5 mm 103 x 23 mm 052598
Brosse dure Brins incurvés 0.7 mm 103 x 23 mm 051812
Brosse souple Brins incurvés 0.5 mm 103 x 23 mm 051850

Speed rpm	Power W	dB	Air consumption l/min	Air pressure bar	cm	kg
4000	500	86	102	6.2	280	1.2

PINCE À SOYER ET À TROUER, Ø5MM PNEUMATIQUE - Pneumatic flange / ø5 mm punching tool - Pneumatische Loch- und Absatzzange Ø 5 mm

052543

2 in 1

Ø 5 mm

0.8 > 1.2 mm

0.8 > 1.2 mm

MINI FRAISEUSE - Mini milling machine - Mini-Schleifer

063228

Option
Tungsten drill Ø 6 mm 054172

OUTIL DE POINÇONNAGE OBLONGS - Punching tool for oval holes - Langlochkarosserieblechzange

2.2 kg

6 mm 20 mm 052437
8 mm 20 mm 067264

BODY ZIPPER - Sertisseuse pneumatique Pneumatic Crimper - Druckluftkantenformer

056930

MADE IN HIGH QUALITY POLAND

1) MINI
2) initial W
3) final M x < 2.4mm
4) final D x > 2.4mm

total thickness x=2a+b

Air pressure bar	cm	kg
5	28	2.1

DÉPOINTEUSE POUR CORDON LASER ACIER - Laser cord metal sheet cutter (nibbler) - Trennwerkzeug für Lasernähte

054165

Ø 6 mm

STEEL Included 054172

DÉPOINTEUSE - Spot remover - Druckluft-Schweißpunktbohrer

SPOT DRILL 050464

360°

Ø 8

Included: Tungsten Carbide Ø 8 for BORON/UHSS (x1)

HIGH QUALITY

Forets de dépointage - Spot remover drill - Schweißpunktfräse Tungsten Carbide for BORON/UHSS

3-edge	Ø 8 mm	Ø 9 mm	Ø 10 mm
053069	069763	053076	
059849	069770		

Speed rpm	Power W	dB	Air consumption l/min	Air pressure bar	cm	kg
800	400	85	140	6.5	35	2.3

PACK SPOT DRILL + 140 mm 061460

140 mm 061453

3-edge Ø 8 mm 053069

140 mm

QR code
Youtube

TOURNEVIS SANS FIL - Cordless Mini Screwdriver - Akkuschauber



DÉTECTEUR ÉPAISSEUR DE PEINTURE - Film coating thickness gauge

Measurement range : 0 - 1.80mm
Resolution : 0.01 mm / 1 mm
Measurement error : +/- 0.03 mm
Power Supply : 2x 1.5V AAA batteries (included)
Overall dimensions : 62 x 30.5 x 105 mm

059856



TOURNEVIS À CHOCS SANS FIL - Cordless Impact Screwdriver - Akkuschauber



PONÇEUSE /POLISSEUSE ÉLECTRIQUE - Electric Sander & Polisher - Elektro-Polier-Schleifer

057999

Orbital 5.0 mm
■ 303 x 101 mm
1.21 kg
Speed : 4000, 7000, 9000 10000 rpm
AC-in 220V - 230V / 50 - 60Hz

Light weight
& Compact



ASPIRATEUR PNEUMATIQUE POUR POUSSIÈRES ALU (ATEX) - Pneumatic aluminium dust atex vacuum cleaner

058866

Dust container capacity : 25 l
Working compressed air pressure : 7 bar
Compressed air consumption at 6 bar : 800 l/min
Suction connection diameter size : 50 mm
Max suction capacity : 150 m³/h
Max vacuum level : 2000 mm H₂O
Recommended compressor power : 7.5 HP

■ 74 x 45 x 45 mm
■ 18 kg



included
Filtre - Filter
058873

included
Sac à poussières - Filter bag
Capacity 5 kg
x5
058880



ASPIRATEUR PNEUMATIQUE POUR PONÇEUSE - Pneumatic dust vacuum cleaner for sander

Aspirateur (sans ponçeuse)
Vacuum cleaner (without sander)
071353
■ 350 x 800 x 400
■ 21 kg

Ponçeuse - Sander
Ø 150 mm
071346



- ✓ **ROBUST**
- ✓ **QUICK & SAFE**
- ✓ **LOW AIR CONSUMPTION**
(5 bar)
- ✓ **NO ELECTRIC MOTOR**
- ✓ **ENERGY SAVING**

INNOVATIVE SUCTION SYSTEM
Depression 1150 mm H₂O
Air flow 600 l/min
Air consumption 340 l/min

Ex ATEX norm
Group II - Category 3



Grande maniabilité et stabilité
- High maneuverability and stability

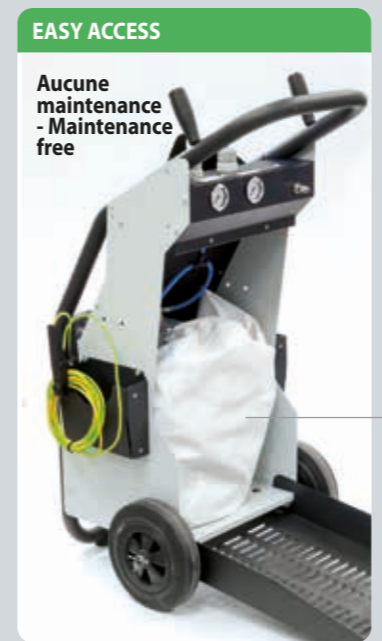

Consumables

Sac à poussières - Filter bag
Capacity 5 kg
Included x1
x5
058880

NEW
10/2021



LAMPES BALADEUSES - Hand lamps - Handleuchte

Lampe BALADEUSE TRIPODE 250 L
100-250 lumens (x3)

3 x 1 W COB LED
3 x 3.6 V - 300 mAh
AAA rechargeable, Ni-MH
USB charging (6h)
operating time
High position : 1 h
Low position : 3 h
Flashing : 5 h



Lampe BALADEUSE PRO 600 L
250-600 lumens

COB LED, 80 CRI
3.7 V - 2200 mAh Li-ion
micro USB charging (3.5 h)
operating time :
High position : 1.5 h,
Mid position : 4.5 h,
Top light (100 lumens) : 10 h



Lampe BALADEUSE 400 L
400 lumens

COB LED
Li-ion
Charging time : 8h
operating time
High position : 2.5 h
Low position : 5 h
Top light (1 W) : 6 h



Lampe BALADEUSE ÉTANCHE 400 L
200-400 lumens

COB LED
3.7 V - 2000 mAh Li-ion
USB charging (4/6 h)
mains charger not included
operating time
High position : 2 h
Mid position : 4 h
Top light (4 W) : 3 h

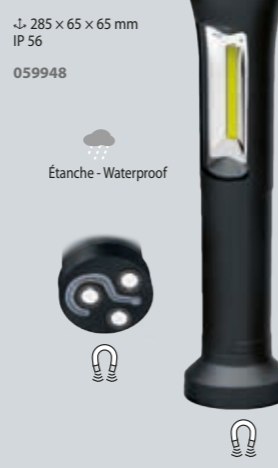

Lampe AMBIANCE 360° PORTABLE 1000 L
60-1000 lumens

>80 CRI SMD LED
6500 K
3.7 V - 5200 mAh Li-ion
USB charging (4.5h)
USB power supply
operating time 2 > 27 h

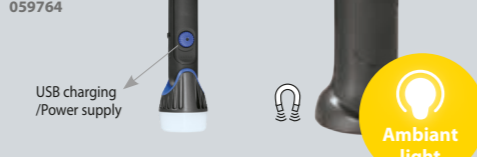

LAMPES D'INSPECTION - Inspection lamps - Inspektionslampen

Lampe INSPECTION FRONTALE 280 L
100-280 lumens

3 W COB LED, 80 CRI+, 6500 K
3.7 V - 1500 mAh Li-po
micro USB charging
mains charger not incl.
operating time
High position : 2 h
Low position : 6 h
IP 65
110 g
78.5 x 47.5 x 42 mm

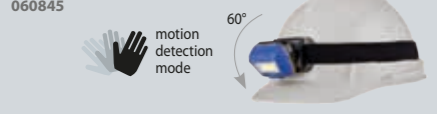

Lampe INSPECTION MINI 200 L
120-200 lumens

COB LED, 80 CRI, 6500 K
3.7 V - 700 mAh Li-ion
micro USB charging (2.5 h)
mains charger not included
operating time
High position : 1.5 h
Low position : 4 h
Top light : 3.5 h
IP 20
76 g, 174 x 27.5 x 28 mm



Lampe INSPECTION FLEXIBLE 500 L
50-500 lumens

COB LED
80 CRI+
6500 K
3.7 V - 2600 mAh Li-ion
USB charging (4 h)
operating time
High position : 2 h
Low position : 16 h
Top light : 9.5 h



Lampe INSPECTION PRO 600 L
0-600 lumens

COB LED
6500 K
3.7 V - 2600 mAh Li-ion
operating time
1.5 > 15 h

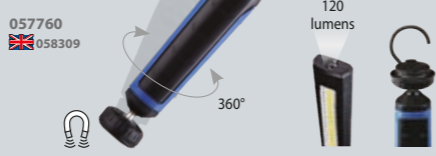

LAMPES SOUS CAPOT - Under bonnet lamps - Leuchte für Motorhaube

Lampe SOUS CAPOT 600 L
300-600 lumens

120 COB LED
3.7 V - 4000 mAh Li-ion
charging time : 10/12 h

operating time
High position : 1.5 h
Low position : 3 h

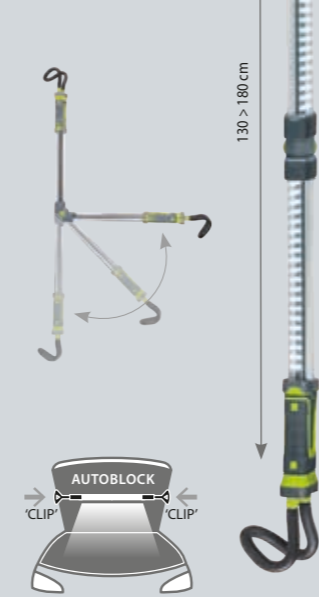

Lampe SOUS CAPOT 800 L
250-800 lumens

120 COB LED
3.7 V - 4000 mAh Li-ion
charging time : 10/12 h

operating time
High position : 3 h
Low position : 6 h



PROJECTEURS LED SUR TRÉPIED - LED worklights with tripod - LED-Arbeitsleuchte mit Standfuß

Lampe sur TRÉPIED 1800 L
1800 lumens

3 x 55 COB LED
total 165 LED
1.8 m power cord
059146



Lampe sur TRÉPIED 3000 L
3000 lumens

35 W COB LED
2 m power cord
IP 44
059979



Lampe sur TRÉPIED 4000 L
4000 lumens

3 x 20 COB LED,
total 60 LED
3 m power cord
059986

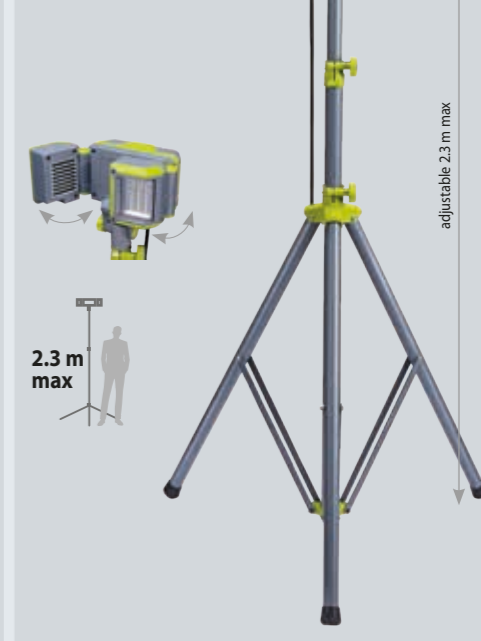

CONTRÔLE DES COULEURS - Detailing & colour match - Fabnpassung & Aufbereitung

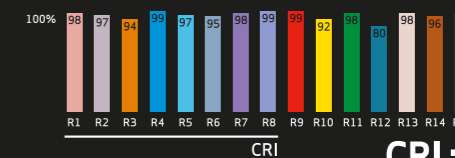

4500 K
400 lumens

SUNCOLOR 1
COB LED, CRI > 95, 1100 lux
3.7 V - 2600 mAh Li-ion
USB charging
operating time : 3 h
190 x 56 x 29 mm
290 g
IP 65



3 COLORS
2700 - 4500 - 6500 K

350-420-450 lumens

SUNCOLOR 3
COB LED, 96 CRI+
3.7 V - 2600 mAh Li-ion
micro USB charging (4 h)
operating time : 2.5/4 h
IP 65
190 x 56 x 29 mm, 290 g



5 COLORS

2700 - 3500 - 4500 - 5500 - 6500 K

500-1000-2000 lumens

SUNCOLOR 5
COB LED, 96 CRI+
11.1 V - 4400 mAh Li-ion
charger 110/240 V, 5 m cable, 15 V, 1.5 A
charging time : 3.5 h
operating time
High position : 2 h, Mid : 4 h, Low : 8 h
IP 65
225 x 200 x 70 mm, 1.2 kg



5 COLORS
2500-3500-4500-5500-6500 K

250-500 lumens

SUNMATCH 3
COB LED, 96 CRI+, 700-1400 lux
3.7 V - 2600 mAh Li-ion, USB charging
operating time :
High position : 2 h, Low position : 4 h
IP 65
204 x 89 x 81 mm, 270 g

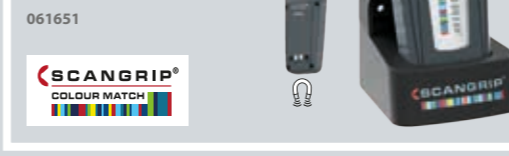

SÉCHAGE UV - UV CURING

UV LED λ 395-400 nm

Irradiance 6-15 mW/cm²

NOVA-UV S

3.7 V - 5400 mAh Li-ion
USB charger, 1 m cable, 5 V, 2 A
charging time : 3.5 h
curing area : Ø 20 cm
operating time 1.5 h
IP 67
163 x 63 x 163 mm





TRÉTEAUX - Frames support - Klappböcke

040601
100.5 x 112 cm - 5.5 kg
35 x 95 x 106 cm
Ø28mm
4 pieds coudés
Idéal sur caillébottis
- Bent feet for grating
- Abgewinkelte Standfüße:
- Sicherer Stand auf Gittern u.ä.

040250
100 x 105 cm - 7kg
32 x 10 x 106 cm
Ø32mm
Chânette réglable
- Adjustable catenary

040311
104.5 x 117 cm - 8.1kg
32 x 10 x 106 cm
Ø32mm
4 ventouses
Dépose vitrages
- Suction pad for glazing
- Gummiteiler zur Fixierung
- von Glasscheiben

040304
104.5 x 108.8 cm - 8.1kg
32 x 10 x 106 cm
Ø32mm
Mousse de protection
- Protecting foam

040304
104.5 x 108.8 cm - 8.1kg
32 x 10 x 106 cm
Ø32mm
Léger et très maniable
Spécial travaux à l'horizontal
- Light and easy to handle
- Ideal for horizontal works
- Speziell geeignet für Arbeiten
- in horizontaler Position

Antidérapants
- Non-slip base

NEW

070677
20 x 20 mm
16.5 kg
15 > 125 cm
88 > 128 cm
3 mm
87 cm
MADE IN HIGH QUALITY POLAND

059818
86 x 67 x 13 cm
25 x 25 mm
24 kg
18.5 > 132 cm
81 > 133 cm
6 mm
86 cm
MADE IN HIGH QUALITY POLAND

**SUPPORT PARE-CHOCS - Rotary element support
Lackierständer für Stoßstange, einstellbar**

052376
91 x 105 cm - 7.6 kg
60 x 11 x 75 cm

Adapté aux coques de rétroviseurs
- Adapted to wing mirror covers
- Geeignet für Außenspiegel

059825
106 x 104 x 215 cm - 32.5 kg
112 x 31.5 x 21.5 cm
+ 12 x 9.5 x 194.5 cm
50 cm

059832
50 x 150 cm - 13 kg
152 x 15.5 x 11.5 cm
50 cm

**SUPPORT ÉLÉMENT ROTATIF - Rotary element support -
Lackierständer für Stoßstange, einstellbar**

052611
200 x 101 cm - 17.5 kg
35 x 15 x 110 cm
Made in China

PRO 056725
200 x 105 x 81 cm - 22 kg
24 x 17 x 118 cm

1.5 mm
360°
2 mm
Verrouillage de l'axe - Locking of the axis
- Verriegelung der Achse

MADE IN HIGH QUALITY POLAND

**CHARIOT EXTENSIBLE POUR ÉLÉMENTS DE CARROSSERIE -
Extendable support - Ausziehbarer Wagen**

061507
max 150 kg
100 cm
26 kg
114.5 x 42 x 13.5 cm
MADE IN HIGH QUALITY POLAND

**CHARIOT DE LUXE MAROUFLAGE - Premium masking machine -
Abdeckpapier-Ständer**

x 5
rouleaux de papier
- Papierständer
- Paper roll
30 > 120 cm
057333
150 x 133 x 62 cm
32 kg
152 x 17 x 29 cm
Ø40 mm x 6
058897

MADE IN HIGH QUALITY POLAND

**CHARIOT DE MAROUFLAGE - Masking machine -
Abdeckpapier-Ständer**

x 3
rouleaux de papier
- Papierständer
- Paper roll
30, 60, 90 cm
056954
150 x 62 x 110 cm
- 12 kg
122 x 29 x 17 cm

MADE IN HIGH QUALITY POLAND

**CHARIOT DE STOCKAGE - Storage trolley -
Lagerrollwagen**

040243
71 x 90 x 197cm
41 kg
x2:
90 x 6 x 147 cm
+ 97 x 74 x 24 cm

TIGES DE BLOCAGE - Flap Lock

056732
30 > 115 cm

**TABOURET - Round Stool with Tool Storage -
Werkstatt-Rollhocker**

057555
38 x 38 x 44 cm - 6 kg
40 x 40 x 18 cm
max : 50 cm
min : 38 cm

SERVANTE 3 PLATEAUX - Workstation 3 shelves

068056
65 kg max
65 kg max
65 kg max
390 mm
800 mm
835 mm
NEW

**CHARIOT DE VISITE - Mechanics Creeper with
Tilting Headrest - Werkstatt-Rollliege**

057548
102 x 43 x 11 cm
7.2 kg
11 x 44 x 13 cm

**MARCHE PIED - Folding Step Stool
(Aluminium) - Arbeitspodest klappbar**

ALU 200 kg
057562
8.2 kg
102 x 41 x 59 cm
960 mm
385 mm
475 mm

**CHARIOT POUR ÉLÉMENTS DE CARROSSERIE -
Universal support - Universelle Ständer**

066281
20 kg
max 80 kg
Ø 4.5 cm
80 cm
70-100 cm
115 cm
Ø 12.5
NEW
MADE IN HIGH QUALITY POLAND

ALU 150 kg

1090 > 1750 mm
520 > 900 mm
300 mm
058552
15.5 kg
116 x 43 x 17 cm - 16.5 kg

COUVERTURE ANTI-CHALEUR - Heat cover - Hitzeschutzdecke - Manta anti-calor - Protecção anti-aquecimento

PROTEC 550
 550°C/1000°F - Class M0
 2m x 2m - 580 g/m²
 050495

PROTEC 1200
 1200°C/2200°F - Class M0
 1,75 m x 1,5 m - 1200 g/m²
 050204

PROTEC 1300
 1300°C/2400°F - Class M0
 XL: 2 m x 1,8 m - 620 g/m²
 053595

PROTEC 1300L
 1300°C/2400°F
 XL: 2 m x 1,8 m - 427 g/m²
 060500

JEU DE 2 AIMANTS

- Set of 2 magnets -
Schweißmagnet

(x2)
052291

COUVERTURE MAGNÉTIQUE - Magnetic cover - Magnetschutzdecke

1,06 m x 0,6 m
061446

RIDEAU DE SOUDAGE - Welding curtain and frame - Schweißerschutzwand

OPTI 215.0
 Orange CE - 2 x 2,15 m
 EN 25980 - 2015/01
 060470

OPTI 200G
 Green T9 - 2 x 2 m
 EN 25980 - 2015/01
 060463

MASQUES RESPIRATOIRES - Respiratory masks - Atemschutzmaske - Máscaras respiratorias

FFP3 - EN 140 / EN 143 / EN 166
 (x1) Size M/L
 037021

FFP3 - EN 140 / EN 143
 (x1) Size M/L
 037014

Étui / Case
 037045

FFP3 - EN 143 : 2000 P3
 Anti poussières / Anti odeurs
 037038

FFP1 (x20) EN 149-2001
 043916

FFP2D-OV M/L (x5) EN 149-2001
 043923

LUNETTES DE PROTECTION

- Protection goggles - Schutzbrillen

EN 166

Shade/IR0
 042810

Shade/IR0
 042827

Shade/IR5
 042841

Shade/IR0
 047778

Shade/IR0
 047792

Shade/IR0
 042865

Shade/IR0
 047839

GANTS - Gloves - Handschuhe - Guantes

Anti coupe - Anti-cut
 T9
 045897

✓ écran tactile - touch screen friendly
 Anti coupe haute résistance
 High resistance anti-cut
 EN 420
 EN 388:4121
 T9: 045910
 T10: 045927

Anti coupe haute dextérité anti-cut
 High dexterity anti-cut
 EN 420
 EN 388:1121
 T9: 045903
 T10: 045934

T10
 064188

EN420
 2003

Ultra Flexible
 EN388
 2003

EN388
 4244

EN 407
 424X4X
 EN12477
 Class: A1

Gants PRO TIG T10
 045194

EN 407
 322X2X
 EN12477
 Class: A1

EN388
 2122

EN 407
 423X4X
 EN12477
 Class: A1

EN388
 2111XX

EN 407
 423X4X
 EN12477
 Class: A1

EN388
 4244

Gants de soudage renforcés - Reinforced welding gloves
 T10
 045873

EN 407
 424X4X
 EN12477
 Class: A1

Gants PRO TIG EXTRA T10
 045323

EN 407
 423X4X
 EN12477
 Class: A1

TABLIER CUIR MULTI-USAGE

- Multi-use leather apron - Delantal de cuero multi-uso - Mehrzweck-Lederschürze

PRO
 045217

ÉQUIPEMENTS POUR OPÉRATIONS SUR VÉHICULES ÉLECTRIQUES & HYBRIDES - Equipment for operations on electric and hybrid vehicles - Ausrüstung für den Betrieb von Elektro- und Hybridfahrzeugen

ÉCRAN FACIAL AVEC SERRE-TÊTE
- FACE SHIELD WITH HEADBAND
068018

NEW

GANTS ISOLANTS (T10)
- INSULATING GLOVES (T10)
068025

NEW

Coffret de 25 outils isolés 1000V - 25 pieces insulated tools 1000V - Box mit 25 isolierten Werkzeugen 1000V
066489

Douilles 7/8/10/12/14/15/17/19/22 mm - 7/8/10/12/14/15/17/19/22 mm sockets	x 9
Pince universelle de 175 mm en chrome vanadium - 175 mm universal pliers in chrome vanadium	x 1
Pince coupante 150 mm en chrome vanadium - Cutting pliers 150 mm in chrome vanadium	x 1
Cluqiet en 3/8" - 3/8" ratchet	x 1
Rallonge 100 mm - Extension 100 mm	x 1
Poignée en T - T-handle	x 1
Clés plates à fourches 7/8/10/12/14/17 mm - Open ended wrenches 7/8/10/12/14/17 mm	x 6
Couteau pour câble - Cable knife	x 1
Tournevis Philips PhH1x100/PhH2x100 mm - Phillips PhH1x100/PhH2x100 mm screwdriver	x 2
Tournevis plats 5.5x125/4x100 mm - Flat screwdriver 5.5x125 / 4x100 mm	x 2

Kit pour le balisage de la zone d'intervention
- Kit for marking the area of intervention - Kennzeichnungsset für Hochvolt-Bereiche
064409

Balise de signalisation rouge et blanche - Red and white warning pole	x 4
Chaîne de délimitation rouge et blanche - Red and white bounding line	x 1
Pancarte de signalisation "Danger, zone de travail VEH" - Sign board "Danger, working area EHV"	x 2

PANTALON - Trousers - Hose

98% cotton, 2% antistatic
 EN ISO 11611 Class 2-A1 & A2
 EN ISO 1149-5
 EN ISO 11612 A1+A2-B1-C1-E3-F1
 IEC 61482-2 Class 1-4kA
 EN 14404 +A1 Type 2

S (40/42) 046368
 M (44/46) 046375
 L (48/50) 046382
 XL (52/54) 046399
 XXL (56/58) 046412

VESTE - Jacket - Jacke

IEC 61482-2 Class 1-4kA
 EN ISO 11612 A1+A2-B1-C1-E3-F1
 EN ISO 11611 Class 2-A1 & A2
 EN 14404 +A1 Type 2
 EN 1149-5

98% cotton, 2% antistatic
 S (40/42) 046313
 M (44/46) 046320
 L (48/50) 046337
 XL (52/54) 046344
 XXL (56/58) 046351

BSU & CHARGERS

BATTERY SUPPORT UNIT

Homologations Approvals Zulassungen APPROVED EQUIPMENT

A FULL RANGE FOR ALL NEEDS



NEW



CATALOGUE 2022



CHARGERS
6 - 12 - 24 - 36 - 48 V

STARTERS & CHARGERS
12 - 24 V

BOOSTERS
6 - 12 - 24 V

TESTERS
12 - 24 V

ACCESSORIES
+

MORE



A COMPLETE RANGE

for 200 > 240 V MONO / TRI
50/60 Hz

DÉBOSSÉLAGE - Dent pulling - デントプラー



SOUDURE PAR POINT - Spotwelding - スポット溶接



RIVETAGE - Riveting - リベット打ち



MIG/MAG TRADITIONNEL - Traditional MIG/MAG - ミグ/マグトラディショナル

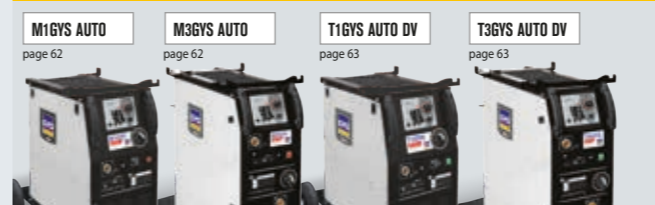

MIG/MAG INVERTER PULSÉ - ミグ/マグパルスインバーター



CHARGEUR - Battery charger - バッテリーチャージャー



DÉCOUPAGE PLASMA - Plasma cutting - プラズマカッター



INDUCTION - インダクション



INDIAN CAR MANUFACTURER APPROVALS / COMPLIANCE

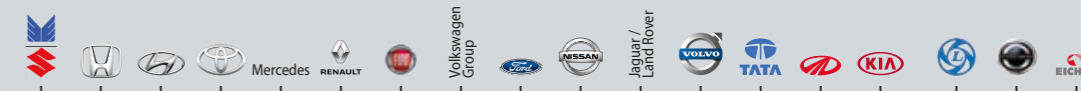

		OEM - CARS										OEM - TRUCKS				
DENT PULLER	GYSPOT 39.02															
	SPEEDLINER															
	GYSPOT ALU FV															
SPOT WELDERS	GYSPOT 32D															
	GYSPOT INVERTER BP-MS/LX/LC/LQC															
	GYSPOT EVOLUTION PTI-s7															
MIG/MAG	CARMIG															
	T1 GYS AUTO															
	T3 GYS AUTO															
PLASMA	NEOPULSE															
	CUTTER 25K															
	CUTTER 30FV															
INDUCTION	GYSDUCTION AUTO															
BATTERY CHARGERS																
TOOLS & TROLLEYS																

INDIAN HOMOLOGATIONS

200 - 208 - 230 - 240 V TRI - 50/60 Hz



GYS FRANCE

HEADQUARTER

1 rue de la Croix des Landes
CS 54159
53941 Saint-Berthevin - Cedex
Laval - France
Tel +33 2 43 01 23 60
E-mail service.client@gys.fr



ZI, 134 bd des Loges
53941 Saint-Berthevin
Laval - France

LOGISTIC CENTER

2 Rue Jean Dausset
53910 Changé - France
Tel +33 2 43 01 54 33



INVEST IN THE FUTURE



French manufacturer
since 1964

INVEST IN THE FUTURE

www.gys.fr



GYS Germany

Professor-Wieler
Straße 11
52070 Aachen
Deutschland

Tel +49 241 / 189-23-710
Fax +49 241 / 189-23-719
E-mail aachen@gys.fr



GYS UK

Unit 3
Great Central Way
Rugby - Warwickshire
CV21 3XH
United Kingdom

Tel +44 1926 338 609
Fax +44 1926 429 764
E-mail uk@gys.fr



GYS ITALIA

Vega - Parco Scientifico Tecnologico
di Venezia
Via Delle Industrie, 25/4
30175 Marghera - VE
Italia

Tel +39 041 53 21 565
E-mail italia@gys.fr



GYS CHINA

Lot N°15
6666 bd Songze
201706 Qingpu Shanghai
China

Tel +86 6221 4461
Fax +86 5226 0067
www.gys-china.com.cn
E-mail contact@gys-china.com.cn

MARKETING

Podium de présentation
- Display stand
- Podest

PODIUM 2
A : 80 cm
B : 50 cm
C : 50 cm
063211

PODIUM 1
A : 45 cm
B : 50 cm
C : 50 cm
063204

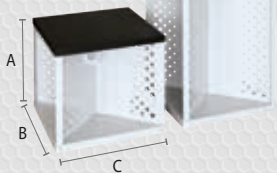

Linéaire de vente avec 2 étagères
- Retail display space with 2 shelves
- Lochwandregal mit 2 Böden
(machines not included)
060784



Barnum 3 x 3 m
098022

Open barnum
2 x 2 m
098039



Oriflamme
- Flag
1,75 x 0,50 m
098015

Distributed by

LinkedIn



Youtube



WeChat



exp. 095045
Document non contractuel. GYS se réserve le droit de modifier sans préavis les spécifications de ses appareils.
Document not contractual. GYS reserves the right to modify the specifications of the machines without prior notice. Irrtümer und Änderungen vorbehalten. • I.P. - 298 g

2
0
2
2

